

WBXG 1" Series

WBXG 3540



15 l/m
4 USGPM



max 240 BAR
3500 P.S.I.

APPLICAZIONI - APPLICATIONS



MANUTENZIONE
MAINTENANCE



PROCESSI INDUSTRIALI
INDUSTRIAL PROCESSES



AUTOLAVAGGIO
CARWASH



EDILIZIA
CONSTRUCTION



SANIFICAZIONE
SANITIZATION

TECHNICAL PLUS:



USCITA ALBERO DX
RIGHT DRIVE SHAFT



CARTER REVERSIBILE, PER USCITA ALBERO SX O DX
REVERSIBLE CRANKCASE FOR LEFT OR RIGHT



BIELLE IN BRONZO
BRONZE CONRODS



GUARNIZIONI TENUTA ACQUA NBR (BUNA)
NBR (BUNA) WATER SEALS

OPTIONAL:



USCITA ALBERO LATO SX
LEFT DRIVE SHAFT

GUARNIZIONI - SEALS



GUARNIZIONI ANTERIORI
"V" - POSTERIORI "U"
"V" FRONT SEALS - "U" BACK SEALS

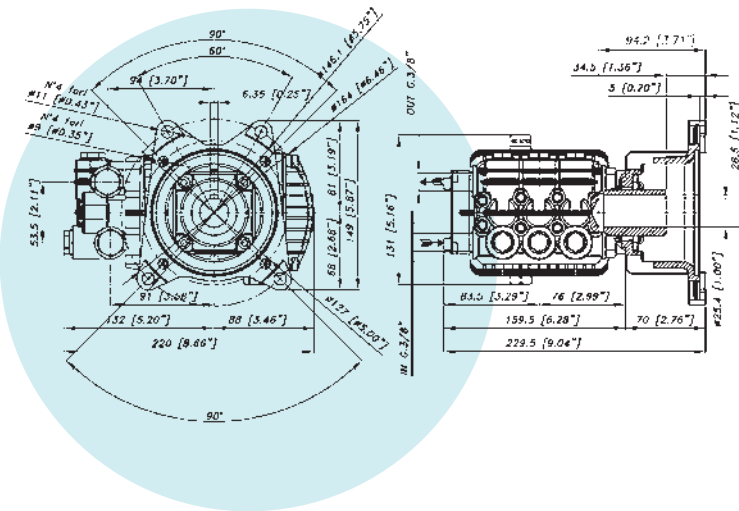

CARATTERISTICHE TECNICHE SPECIFICATIONS

Peso - Weight	7 Kg	14.4 lb
IN	3/8 BSP	
Pressione Min - Min Pressure	1 BAR	15 P.S.I.
Pressione Max - Max Pressure	6 BAR	87 P.S.I.
OUT	3/8 BSP	
Albero - Shaft	HOLLOW Ø 1"	
Max. Temperatura - Max. Temperature	60 °C	140 °F
Tipo olio - Oil type	SAE 75 - W 90	
Capacità olio - Oil capacity	0,5 lt	0.13 U.S.G.
Predisposta per motore - For Engine	SAE J609-1"	

WBXG 1" Series
WBXG 3540



15 l/m
4 USGPM



max 240 BAR
3500 P.S.I.

CODICE CODE	MODELLO MODEL	Press. Max Max Pres.		RPM 3450					Pist. Plung.	Corsa Stroke
				Portata-Flow		Potenza-Power				
		BAR	P.S.I.	L/min	GPM	KW	HP	HP Engine	Dia. mm	mm
02.6170.97.3	WBXG 3030	210	3000	11,4	3	4,7	6,2	7	15	7,2
02.6171.97.3	WBXG 3530	240	3500	11,4	3	5,4	7,3	8	15	7,2
02.6172.97.3	WBXG 3035	210	3000	13,2	3,5	5,4	7,3	8	15	8,6
02.6173.97.3	WBXG 3535	240	3500	13,2	3,5	6,3	8,4	10	15	8,6
02.6174.97.3	WBXG 3040	210	3000	15	4	6,2	8,3	10	15	9,8
02.6175.97.3	WBXG 3540	240	3500	15	4	7,1	9,6	12	15	9,8