

WBS/WBS-F Series

WBS 1821-F



8 l/m
2.1 USGPM



max 125 BAR
1800 P.S.I.

APPLICAZIONI - APPLICATIONS



MANUTENZIONE
MAINTENANCE



PROCESSI INDUSTRIALI
INDUSTRIAL PROCESSES



AUTOLAVAGGIO
CARWASH



EDILIZIA
CONSTRUCTION



SANIFICAZIONE
SANITIZATION

TECHNICAL PLUS:



USCITA ALBERO DX
RIGHT DRIVE SHAFT



CARTER REVERSIBILE, PER USCITA ALBERO SX O DX
REVERSIBLE CRANKCASE FOR LEFT OR RIGHT



BIELLE IN LEGA TONOLLI 328
CONRODS IN HYPER 328 TONOLLI ALLOY



GUARNIZIONI TENUTA ACQUA NBR (BUNA)
NBR (BUNA) WATER SEALS

OPTIONAL:



USCITA ALBERO LATO SX
LEFT DRIVE SHAFT



BIELLE IN BRONZO
BRONZE CONRODS



FLANGIA E GIUNTO ELASTICO PER MOT. ELETTR. B3 -B14
BELL HOUSING AND FLEXIBLE COUPLING FOR ELECTRIC
MOTOR B3 -B14

GUARNIZIONI - SEALS



GUARNIZIONI ANTERIORI
"V" - POSTERIORI "U"
"V" FRONT SEALS - "U" BACK SEALS

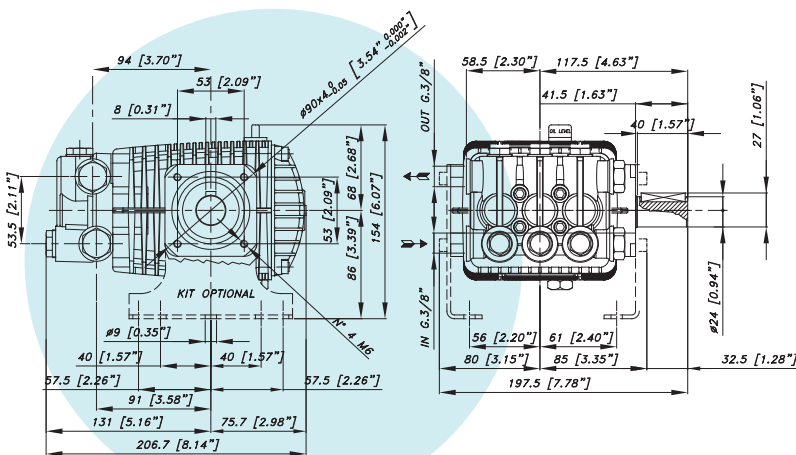

CARATTERISTICHE TECNICHE SPECIFICATIONS

Peso - Weight	5,8 Kg	12.8 lb
IN	3/8 BSP	
Pressione Min - Min Pressure	1 BAR	15 P.S.I.
Pressione Max - Max Pressure	6 BAR	87 P.S.I.
OUT	3/8 BSP	
Albero - Shaft	Ø 24 mm	
Max. Temperatura - Max. Temperature	60 °C	140 °F
Tipo olio - Oil type	SAE 75 - W 90	
Capacità olio - Oil capacity	0,5 lt	0.13 U.S.G.

WBS/WBS-F Series
WBS 1821-F



8 l/m
2.1 USGPM



max 125 BAR
1800 P.S.I.

CODICE CODE	MODELLO MODEL	Press. Max Max Pres.		RPM 3450				Pist. Plung.	Corsa Stroke
				Portata-Flow		Potenza-Power			
		BAR	P.S.I.	L/min	GPM	KW	HP	Dia. mm	mm
02.6110.97.3	WBS 1421-F	95	1400	8	2,1	1,5	2	15	4,8
02.6111.97.3	WBS 1821-F	125	1800	8	2,1	1,9	2,5	15	4,8
02.6112.97.3	WBS 2121-F	145	2100	8	2,1	2,2	2,9	15	4,8
02.6113.97.3	WBS 1335-F	90	1300	13	3,4	2,2	3	15	8
02.6114.97.3	WBS 1735-F	115	1700	13	3,4	3	4	15	8
02.6115.97.3	WBS 2235-F	150	2200	13	3,4	3,8	5,1	15	8