

WBL Series

WBL 917



9 l/m
2.3 USGPM



max 170 BAR
2400 P.S.I.

APPLICAZIONI - APPLICATIONS



MANUTENZIONE
MAINTENANCE



PROCESSI INDUSTRIALI
INDUSTRIAL PROCESSES



AUTOLAVAGGIO
CARWASH



EDILIZIA
CONSTRUCTION



SANIFICAZIONE
SANITIZATION

TECHNICAL PLUS:



USCITA ALBERO DX
RIGHT DRIVE SHAFT



CARTER REVERSIBILE, PER USCITA ALBERO SX O DX
REVERSIBLE CRANKCASE FOR LEFT OR RIGHT



BIELLE IN LEGA TONOLLI 328
CONRODS IN HYPER 328 TONOLLI ALLOY



GUARNIZIONI TENUTA ACQUA NBR (BUNA)
NBR (BUNA) WATER SEALS

OPTIONAL:



USCITA ALBERO LATO SX
LEFT DRIVE SHAFT



BIELLE IN BRONZO
BRONZE CONRODS



FLANGIA E GIUNTO ELASTICO PER MOT. Elett. B3 - B14
BELL HOUSING AND FLEXIBLE COUPLING FOR ELECTRIC
MOTOR B3 - B14

GUARNIZIONI - SEALS



GUARNIZIONI ANTERIORI
"V" - POSTERIORI "U"
"V" FRONT SEALS - "U" BACK SEALS

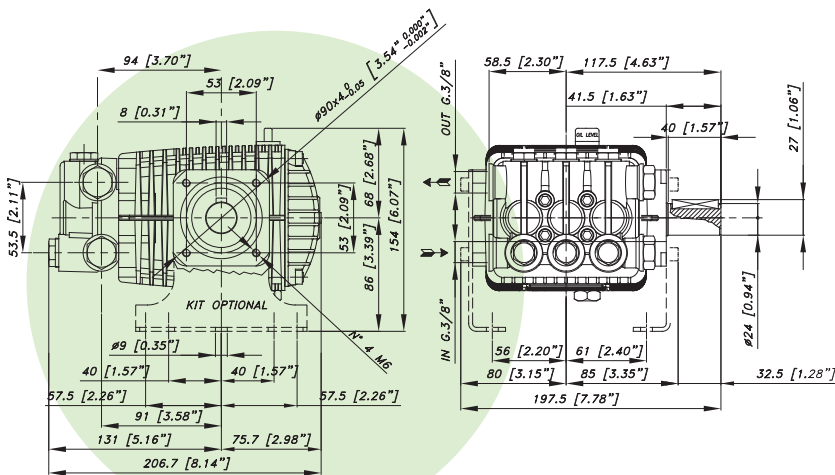

CARATTERISTICHE TECNICHE SPECIFICATIONS

Peso - Weight	5,8 Kg	12.8 lb
IN	3/8 BSP	
Pressione Min - Min Pressure	-0,1 BAR	-1.5 P.S.I.
Pressione Max - Max Pressure	6 BAR	87 P.S.I.
OUT	3/8 BSP	
Albero - Shaft	Ø 24 mm	
Max. Temperatura - Max. Temperature	60 °C	140 °F
Tipo olio - Oil type	SAE 75 - W 90	
Capacità olio - Oil capacity	0,5 lt	0.13 U.S.G.

WBL Series
WBL 917



9 l/m
2.3 USGPM



max 170 BAR
2400 P.S.I.

CODICE CODE	MODELLO MODEL	Press. Max Max Pres.		RPM 1450				Pist. Plung.	Corsa Stroke
				Portata-Flow		Potenza-Power			
		BAR	P.S.I.	L/min	GPM	KW	HP	Dia. mm	mm
02.6000.97.3	WBL 810	100	1450	8	2,1	1,4	1,9	18	7
02.6001.97.3	WBL 813	130	1900	8	2,1	1,9	2,5	18	7
02.6002.97.3	WBL 816	160	2300	8	2,1	2,2	3	18	7
02.6003.97.3	WBL 911	110	1600	9	2,3	1,8	2,4	18	8
02.6004.97.3	WBL 913	130	1900	9	2,3	2,1	2,8	18	8
02.6005.97.3	WBL 917	170	2400	9	2,3	2,7	3,6	18	8
02.6006.97.3	WBL 1010	100	1450	10	2,6	1,9	2,5	18	9,2
02.6007.97.3	WBL 1012	120	1750	10	2,6	2,3	3	18	9,2
02.6008.97.3	WBL 1016	160	2300	10	2,6	2,9	3,9	18	9,2
02.6009.97.3	WBL 1109	90	1300	11	2,9	1,8	2,5	18	10
02.6010.97.3	WBL 1111	110	1600	11	2,9	2,2	3	18	10
02.6011.97.3	WBL 1115	150	2200	11	2,9	3	4	18	10
02.6012.97.3	WBL 1312	120	1750	13	3,4	3	4	18	12,4