

WBL-F Series

WBL 812-F



8 l/m
2.1 USGPM



max 120 BAR
1750 P.S.I.

APPLICAZIONI - APPLICATIONS



MANUTENZIONE
MAINTENANCE



PROCESSI INDUSTRIALI
INDUSTRIAL PROCESSES



AUTOLAVAGGIO
CARWASH



EDILIZIA
CONSTRUCTION



SANIFICAZIONE
SANITIZATION

TECHNICAL PLUS:



USCITA ALBERO DX
RIGHT DRIVE SHAFT



CARTER REVERSIBILE, PER USCITA ALBERO SX O DX
REVERSIBLE CRANKCASE FOR LEFT OR RIGHT



BIELLE IN LEGA TONOLLI 328
CONRODS IN HYPER 328 TONOLLI ALLOY



GUARNIZIONI TENUTA ACQUA NBR (BUNA)
NBR (BUNA) WATER SEALS

OPTIONAL:



USCITA ALBERO LATO SX
LEFT DRIVE SHAFT



BIELLE IN BRONZO
BRONZE CONRODS



FLANGIA E GIUNTO ELASTICO PER MOT. ELETT. B3 -B14
BELL HOUSING AND FLEXIBLE COUPLING FOR ELECTRIC MOTOR B3 -B14

GUARNIZIONI - SEALS



GUARNIZIONI ANTERIORI
"V" - POSTERIORI "U"
"V" FRONT SEALS - "U" BACK SEALS

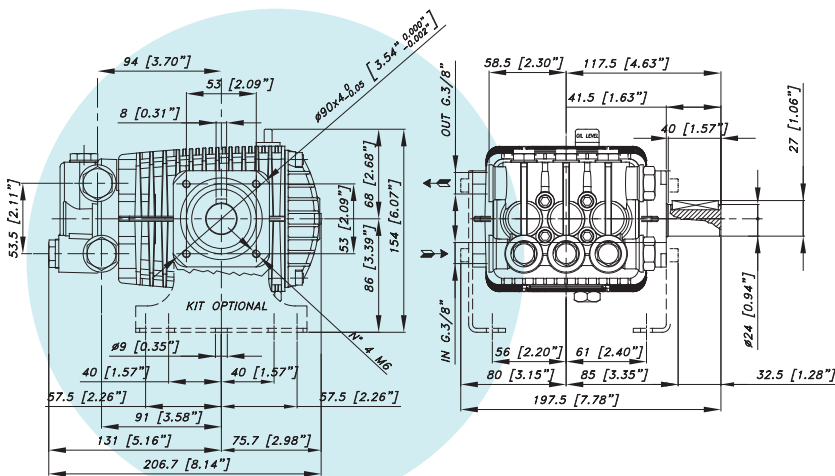

CARATTERISTICHE TECNICHE

SPECIFICATIONS

Peso - Weight	5,8 Kg	12.8 lb
IN	3/8 BSP	
Pressione Min - Min Pressure	1 BAR	15 P.S.I.
Pressione Max - Max Pressure	6 BAR	87 P.S.I.
OUT	3/8 BSP	
Albero - Shaft	Ø 24 mm	
Max. Temperatura - Max. Temperature	60 °C	140 °F
Tipo olio - Oil type	SAE 75 - W 90	
Capacità olio - Oil capacity	0,5 lt	0.13 U.S.G.



CODICE CODE	MODELLO MODEL	Press. Max Max Pres.		RPM 2800				Pist. Plung.	Corsa Stroke
		BAR	P.S.I.	Portata-Flow		Potenza-Power			
				L/min	GPM	KW	HP	Dia. mm	mm
02.6020.97.3	WBL 809-F	90	1300	8	2,1	1,4	1,9	15	6
02.6021.97.3	WBL 812-F	120	1750	8	2,1	1,9	2,5	15	6
02.6022.97.3	WBL 814-F	140	2000	8	2,1	2,2	2,9	15	6
02.6023.97.3	WBL 1010-F	100	1450	10	2,6	1,8	2,5	15	7
02.6024.97.3	WBL 1012-F	120	1750	10	2,6	2,2	2,9	15	7
02.6025.97.3	WBL 1016-F	160	2300	10	2,6	2,9	3,9	15	7
02.6026.97.3	WBL 1110-F	100	1450	11	2,9	2,1	2,8	15	8
02.6027.97.3	WBL 1114-F	140	2000	11	2,9	2,9	3,9	15	8
02.6028.97.3	WBL 1309-F	90	1300	13	3,4	2,2	2,9	15	9,2
02.6029.97.3	WBL 1312-F	120	1750	13	3,4	2,8	3,8	15	9,2
02.6032.97.3	WBL 1410-F	110	1600	14	3,7	2,9	3,9	15	10