

# WBH-F Series

## WBH 2525-F

9.5 l/m  
2.5 USGPM



max 175 BAR  
2500 P.S.I.

### APPLICAZIONI - APPLICATIONS



MANUTENZIONE  
MAINTENANCE



PROCESSI INDUSTRIALI  
INDUSTRIAL PROCESSES



AUTOLAVAGGIO  
CARWASH



EDILIZIA  
CONSTRUCTION



SANIFICAZIONE  
SANITIZATION

### TECHNICAL PLUS:



USCITA ALBERO DX  
RIGHT DRIVE SHAFT



CARTER REVERSIBILE, PER USCITA ALBERO SX O DX  
REVERSIBLE CRANKCASE FOR LEFT OR RIGHT



BIELLE IN LEGA TONOLLI 328  
CONRODS IN HYPER 328 TONOLLI ALLOY



GUARNIZIONI TENUTA ACQUA NBR (BUNA)  
NBR (BUNA) WATER SEALS

### OPTIONAL:



USCITA ALBERO LATO SX  
LEFT DRIVE SHAFT



BIELLE IN BRONZO  
BRONZE CONRODS

### GUARNIZIONI - SEALS



GUARNIZIONI ANTERIORI  
"V" - POSTERIORI "U"  
"V" FRONT SEALS - "U" BACK SEALS

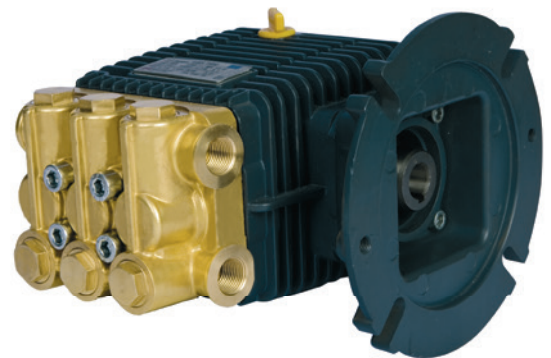
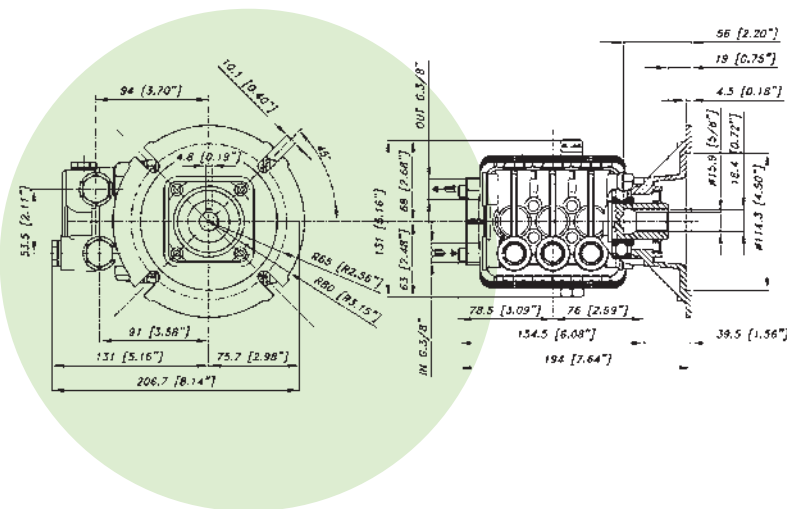

### CARATTERISTICHE TECNICHE SPECIFICATIONS

<b>Peso - Weight</b>	<b>6,1 Kg</b>	13.4 lb
<b>IN</b>	<b>3/8 BSP</b>	
<b>Pressione Min - Min Pressure</b>	<b>1 BAR</b>	15 P.S.I.
<b>Pressione Max - Max Pressure</b>	<b>6 BAR</b>	87 P.S.I.
<b>OUT</b>	<b>3/8 BSP</b>	
<b>Albero - Shaft</b>	<b>HOLLOW Ø 5/8"</b>	
<b>Max. Temperatura - Max. Temperature</b>	<b>60 °C</b>	140 °F
<b>Tipo olio - Oil type</b>	<b>SAE 75 - W 90</b>	
<b>Capacità olio - Oil capacity</b>	<b>0,5 lt</b>	0.13 U.S.G.
<b>Predisposta per motore - For Motor</b>	<b>NEMA 56C-5/8"</b>	



CODICE CODE	MODELLO MODEL	Press. Max Max Pres.		RPM 3450				Pist. Plung.	Corsa Stroke
				Portata-Flow		Potenza-Power			
		BAR	P.S.I.	L/min	GPM	KW	HP	Dia. mm	mm
02.6120.97.3	WBH 1521-F	105	1500	7,8	2,1	1,6	2,1	15	4,8
02.6121.97.3	WBH 2021-F	140	2000	7,8	2,1	2,1	2,8	15	4,8
02.6122.97.3	WBH 2521-F	175	2500	7,8	2,1	2,6	3,5	15	4,8
02.6123.97.3	WBH 1725-F	115	1700	9,5	2,5	2,2	3	15	6
02.6124.97.3	WBH 2525-F	175	2500	9,5	2,5	3,2	4,3	15	6
02.6125.97.3	WBH 1430-F	95	1400	11,7	3,1	2,2	3	15	7,2
02.6126.97.3	WBH 1930-F	130	1900	11,7	3,1	3	4	15	7,2
02.6127.97.3	WBH 2430-F	170	2400	11,7	3,1	3,7	5	15	7,2
02.6128.97.3	WBH 1537-F	105	1500	14	3,7	2,8	3,8	15	8,6
02.6129.97.3	WBH 2037-F	140	2000	14	3,7	3,7	5	15	8,6