

WBH-F Series

WBH 2021-F



7.8 l/m
2.1 USGPM



max 140 BAR
2000 P.S.I.

APPLICAZIONI - APPLICATIONS



MANUTENZIONE
MAINTENANCE



PROCESSI INDUSTRIALI
INDUSTRIAL PROCESSES



AUTOLAVAGGIO
CARWASH



EDILIZIA
CONSTRUCTION



SANIFICAZIONE
SANITIZATION

TECHNICAL PLUS:



USCITA ALBERO DX
RIGHT DRIVE SHAFT



CARTER REVERSIBILE, PER USCITA ALBERO SX O DX
REVERSIBLE CRANKCASE FOR LEFT OR RIGHT



BIELLE IN LEGA TONOLLI 328
CONRODS IN HYPER 328 TONOLLI ALLOY



GUARNIZIONI TENUTA ACQUA NBR (BUNA)
NBR (BUNA) WATER SEALS

OPTIONAL:



USCITA ALBERO LATO SX
LEFT DRIVE SHAFT



BIELLE IN BRONZO
BRONZE CONRODS

GUARNIZIONI - SEALS



GUARNIZIONI ANTERIORI
"V" - POSTERIORI "U"
"V" FRONT SEALS - "U" BACK SEALS

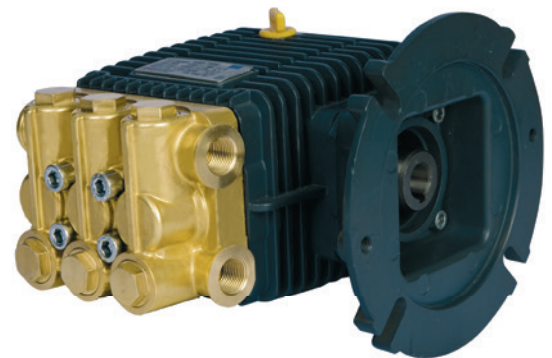
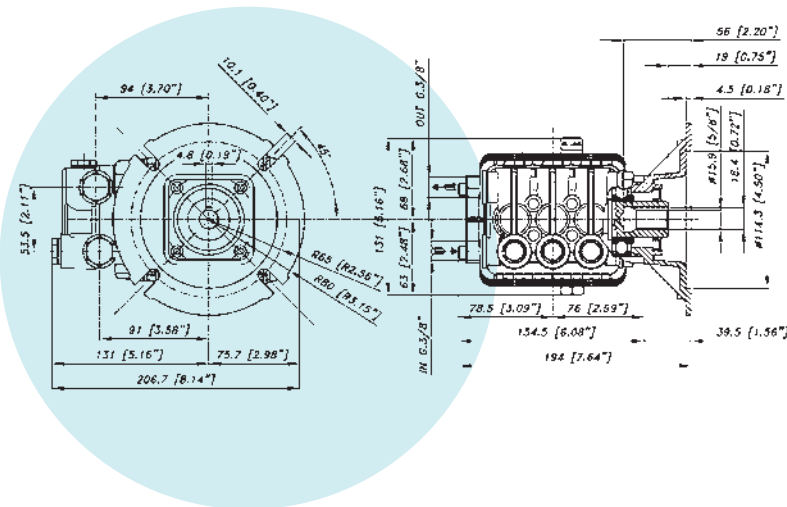

CARATTERISTICHE TECNICHE SPECIFICATIONS

Peso - Weight	6,1 Kg	13.4 lb
IN	3/8 BSP	
Pressione Min - Min Pressure	1 BAR	15 P.S.I.
Pressione Max - Max Pressure	6 BAR	87 P.S.I.
OUT	3/8 BSP	
Albero - Shaft	HOLLOW Ø 5/8"	
Max. Temperatura - Max. Temperature	60 °C	140 °F
Tipo olio - Oil type	SAE 75 - W 90	
Capacità olio - Oil capacity	0,5 lt	0.13 U.S.G.
Predisposta per motore - For Motor	NEMA 56C-5/8"	



CODICE CODE	MODELLO MODEL	Press. Max Max Pres.		RPM 3450				Pist. Plung.	Corsa Stroke
				Portata-Flow		Potenza-Power			
		BAR	P.S.I.	L/min	GPM	KW	HP	Dia. mm	mm
02.6120.97.3	WBH 1521-F	105	1500	7,8	2,1	1,6	2,1	15	4,8
02.6121.97.3	WBH 2021-F	140	2000	7,8	2,1	2,1	2,8	15	4,8
02.6122.97.3	WBH 2521-F	175	2500	7,8	2,1	2,6	3,5	15	4,8
02.6123.97.3	WBH 1725-F	115	1700	9,5	2,5	2,2	3	15	6
02.6124.97.3	WBH 2525-F	175	2500	9,5	2,5	3,2	4,3	15	6
02.6125.97.3	WBH 1430-F	95	1400	11,7	3,1	2,2	3	15	7,2
02.6126.97.3	WBH 1930-F	130	1900	11,7	3,1	3	4	15	7,2
02.6127.97.3	WBH 2430-F	170	2400	11,7	3,1	3,7	5	15	7,2
02.6128.97.3	WBH 1537-F	105	1500	14	3,7	2,8	3,8	15	8,6
02.6129.97.3	WBH 2037-F	140	2000	14	3,7	3,7	5	15	8,6