

WBH Series

WBH 1525



8.7 l/m
2.3 USGPM



max 105 BAR
1500 P.S.I.

APPLICAZIONI - APPLICATIONS



MANUTENZIONE
MAINTENANCE



PROCESSI INDUSTRIALI
INDUSTRIAL PROCESSES



AUTOLAVAGGIO
CARWASH



EDILIZIA
CONSTRUCTION



SANIFICAZIONE
SANITIZATION

TECHNICAL PLUS:



USCITA ALBERO DX
RIGHT DRIVE SHAFT



CARTER REVERSIBILE, PER USCITA ALBERO SX O DX
REVERSIBLE CRANKCASE FOR LEFT OR RIGHT



BIELLE IN LEGA TONOLLI 328
CONRODS IN HYPER 328 TONOLLI ALLOY



GUARNIZIONI TENUTA ACQUA NBR (BUNA)
NBR (BUNA) WATER SEALS

OPTIONAL:



USCITA ALBERO LATO SX
LEFT DRIVE SHAFT



BIELLE IN BRONZO
BRONZE CONRODS

GUARNIZIONI - SEALS



GUARNIZIONI ANTERIORI
"V" - POSTERIORI "U"
"V" FRONT SEALS - "U" BACK SEALS

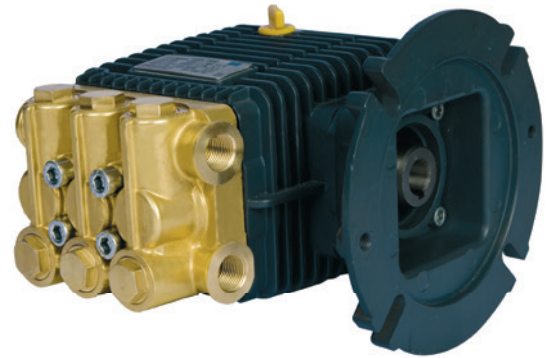
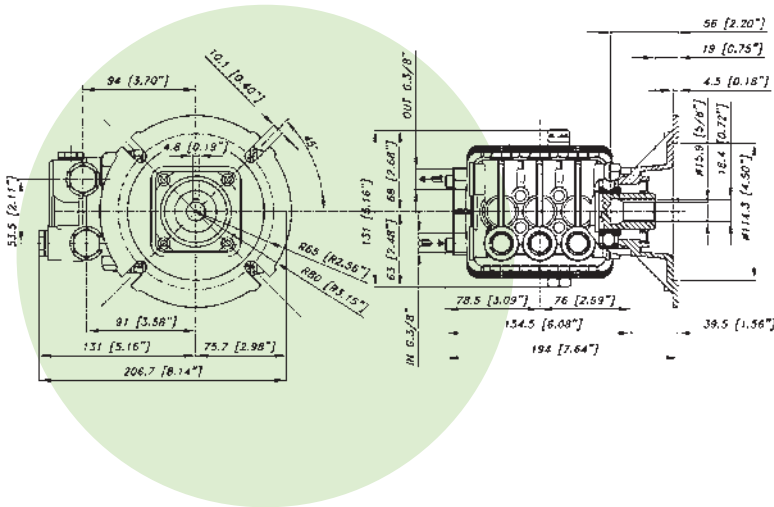

CARATTERISTICHE TECNICHE SPECIFICATIONS

Peso - Weight	6,1 Kg	13.4 lb
IN	3/8 BSP	
Pressione Min - Min Pressure	-0,1 BAR	-1.5 P.S.I.
Pressione Max - Max Pressure	6 BAR	87 P.S.I.
OUT	3/8 BSP	
Albero - Shaft	HOLLOW Ø 5/8"	
Max. Temperatura - Max. Temperature	60 °C	140 °F
Tipo olio - Oil type	SAE 75 - W 90	
Capacità olio - Oil capacity	0,5 lt	0.13 U.S.G.
Predisposta per motore - For Motor	NEMA 56C-5/8"	



CODICE CODE	MODELLO MODEL	Press. Max Max Pres.		RPM 1725				Pist. Plung.	Corsa Stroke
				Portata-Flow		Potenza-Power			
		BAR	P.S.I.	L/min	GPM	KW	HP	Dia. mm	mm
02.6100.97.3	WBH 1520	105	1500	7,6	2	1,5	2	18	6
02.6101.97.3	WBH 1920	130	1900	7,6	2	1,8	2,5	18	6
02.6102.97.3	WBH 1525	105	1500	8,7	2,3	1,8	2,4	18	7,2
02.6103.97.3	WBH 1925	130	1900	8,7	2,3	2,2	3	18	7,2
02.6104.97.3	WBH 2525	175	2500	8,7	2,3	2,9	3,9	18	7,2
02.6105.97.3	WBH 1530	105	1500	10,4	2,8	2,1	2,8	18	8,6
02.6106.97.3	WBH 2130	145	2100	10,4	2,8	2,9	3,9	18	8,6
02.6107.97.3	WBH 1432	95	1400	12	3,1	2,2	3	18	9,8
02.6108.97.3	WBH 1932	130	1900	12	3,1	3	4	18	9,8