

WBG-W Series

WBG 2530-W



11.4 l/m
3 USGPM



max 175 BAR
2500 P.S.I.

APPLICAZIONI - APPLICATIONS



MANUTENZIONE
MAINTENANCE



PROCESSI INDUSTRIALI
INDUSTRIAL PROCESSES



AUTOLAVAGGIO
CARWASH



EDILIZIA
CONSTRUCTION



SANIFICAZIONE
SANITIZATION

TECHNICAL PLUS:



USCITA ALBERO DX
RIGHT DRIVE SHAFT



CARTER REVERSIBILE, PER USCITA ALBERO SX O DX
REVERSIBLE CRANKCASE FOR LEFT OR RIGHT



BIELLE IN LEGA TONOLLI 328
CONRODS IN HYPER 328 TONOLLI ALLOY



GUARNIZIONI TENUTA ACQUA NBR (BUNA)
NBR (BUNA) WATER SEALS

OPTIONAL:



BIELLE IN BRONZO
BRONZE CONRODS

GUARNIZIONI - SEALS



GUARNIZIONI ANTERIORI
"V" - POSTERIORI "U"
"V" FRONT SEALS - "U" BACK SEALS

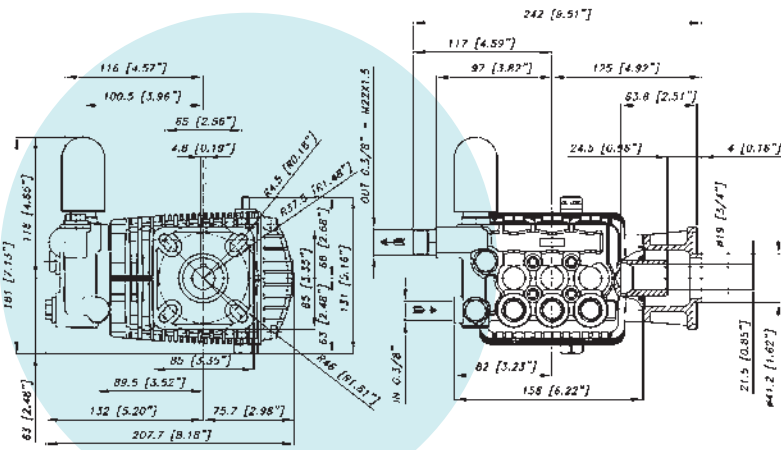

CARATTERISTICHE TECNICHE SPECIFICATIONS

Peso - Weight	7 Kg	15.4 lb
IN	3/8 BSP	
Pressione Min - Min Pressure	1 BAR	15 P.S.I.
Pressione Max - Max Pressure	6 BAR	87 P.S.I.
OUT	3/8 BSP	
Albero - Shaft	HOLLOW Ø 3/4"	
Max. Temperatura - Max. Temperature	60 °C	140 °F
Tipo olio - Oil type	SAE 75 - W 90	
Capacità olio - Oil capacity	0,5 lt	0.13 U.S.G.
Predisposta per motore - For Engine	SAE J609-3/4"	

WBG-W Series
WBG 2530-W



11.4 l/m
3 USGPM



max 175 BAR
2500 P.S.I.

CODICE CODE	MODELLO MODEL	Press. Max Max Pres.		RPM 3450					Pist. Plung.	Corsa Stroke
				Portata-Flow		Potenza-Power				
		BAR	P.S.I.	L/min	GPM	KW	HP	HP Engine	Dia. mm	mm
02.6180.97.A	WBG 1521-W	105	1500	8	2,1	1,6	2,1	3,5	15	4,8
02.6181.97.A	WBG 2021-W	140	2000	8	2,1	2,1	2,8	4	15	4,8
02.6182.97.A	WBG 2521-W	175	2500	8	2,1	2,6	3,5	5	15	4,8
02.6183.97.A	WBG 1625-W	110	1600	9,5	2,5	2,1	2,8	4	15	6
02.6184.97.A	WBG 2025-W	140	2000	9,5	2,5	2,6	3,5	5	15	6
02.6185.97.A	WBG 2525-W	175	2500	9,5	2,5	3,2	4,3	6	15	6
02.6186.97.A	WBG 1630-W	110	1600	11,4	3	2,5	3,4	5	15	7,2
02.6187.97.A	WBG 2030-W	140	2000	11,4	3	3,1	4,2	5,5	15	7,2
02.6188.97.A	WBG 2530-W	175	2500	11,4	3	3,8	5,1	6,5	15	7,2
02.6189.97.A	WBG 1535-W	105	1500	13,2	3,5	2,6	3,5	5	15	8
02.6190.97.A	WBG 2035-W	140	2000	13,2	3,5	3,5	4,7	6,5	15	8
02.6191.97.A	WBG 2535-W	175	2500	13,2	3,5	4,3	5,8	6,5	15	8