

# WBG Series

## WBG 2021



8 l/m  
2.1 USGPM



max 140 BAR  
2000 P.S.I.

### APPLICAZIONI - APPLICATIONS



MANUTENZIONE  
MAINTENANCE



PROCESSI INDUSTRIALI  
INDUSTRIAL PROCESSES



AUTOLAVAGGIO  
CARWASH



EDILIZIA  
CONSTRUCTION



SANIFICAZIONE  
SANITIZATION

### TECHNICAL PLUS:



USCITA ALBERO DX  
RIGHT DRIVE SHAFT



CARTER REVERSIBILE, PER USCITA ALBERO SX O DX  
REVERSIBLE CRANKCASE FOR LEFT OR RIGHT



BIELLE IN LEGA TONOLLI 328  
CONRODS IN HYPER 328 TONOLLI ALLOY



GUARNIZIONI TENUTA ACQUA NBR (BUNA)  
NBR (BUNA) WATER SEALS

### OPTIONAL:



USCITA ALBERO LATO SX  
LEFT DRIVE SHAFT



BIELLE IN BRONZO  
BRONZE CONRODS

### GUARNIZIONI - SEALS



GUARNIZIONI ANTERIORI  
"V" - POSTERIORI "U"  
"V" FRONT SEALS - "U" BACK SEALS

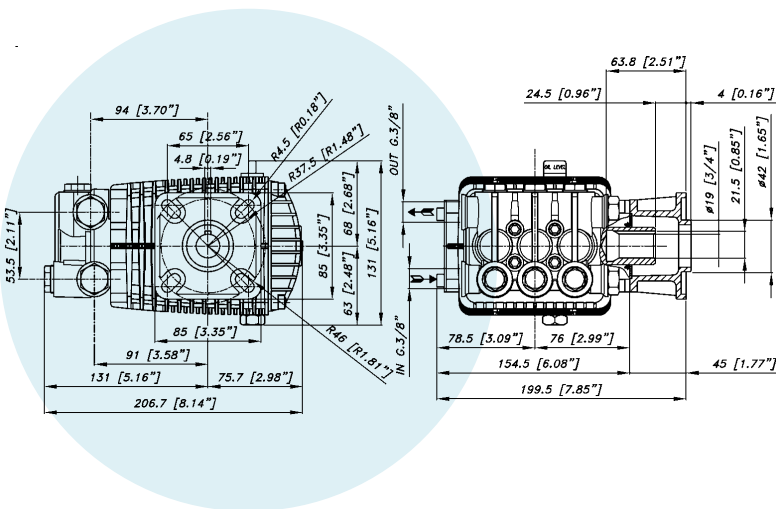

### CARATTERISTICHE TECNICHE SPECIFICATIONS

<b>Peso - Weight</b>	<b>6 Kg</b>	13.2 lb
<b>IN</b>	<b>3/8 BSP</b>	
<b>Pressione Min - Min Pressure</b>	<b>1 BAR</b>	15 P.S.I.
<b>Pressione Max - Max Pressure</b>	<b>6 BAR</b>	87 P.S.I.
<b>OUT</b>	<b>3/8 BSP</b>	
<b>Albero - Shaft</b>	<b>HOLLOW Ø 3/4"</b>	
<b>Max. Temperatura - Max. Temperature</b>	<b>60 °C</b>	140 °F
<b>Tipo olio - Oil type</b>	<b>SAE 75 - W 90</b>	
<b>Capacità olio - Oil capacity</b>	<b>0,5 lt</b>	0.13 U.S.G.
<b>Predisposta per motore - For Engine</b>	<b>SAE J609-3/4"</b>	

WBG Series  
**WBG 2021**



8 l/m  
2.1 USGPM



max 140 BAR  
2000 P.S.I.

CODICE CODE	MODELLO MODEL	Press. Max Max Pres.		RPM 3450					Pist. Plung.	Corsa Stroke
				Portata-Flow		Potenza-Power				
		BAR	P.S.I.	L/min	GPM	KW	HP	HP Engine	Dia. mm	mm
02.6150.97.3	WBG 1521	105	1500	8	2,1	1,6	2,1	3,5	15	4,8
02.6151.97.3	WBG 2021	140	2000	8	2,1	2,1	2,8	4	15	4,8
02.6152.97.3	WBG 2521	175	2500	8	2,1	2,6	3,5	5	15	4,8
02.6153.97.3	WBG 1625	110	1600	9,5	2,5	2,1	2,8	4	15	6
02.6154.97.3	WBG 2025	140	2000	9,5	2,5	2,6	3,5	5	15	6
02.6155.97.3	WBG 2525	175	2500	9,5	2,5	3,2	4,3	6	15	6
02.6156.97.3	WBG 1630	110	1600	11,4	3	2,5	3,4	5	15	7,2
02.6157.97.3	WBG 2030	140	2000	11,4	3	3,1	4,2	5,5	15	7,2
02.6158.97.3	WBG 2530	175	2500	11,4	3	3,8	5,1	6,5	15	7,2
02.6159.97.3	WBG 1535	105	1500	13,2	3,5	2,6	3,5	5	15	8
02.6160.97.3	WBG 2035	140	2000	13,2	3,5	3,5	4,7	6,5	15	8
02.6161.97.3	WBG 2535	175	2500	13,2	3,5	4,3	5,8	6,5	15	8