

WBG Series

WBG 1535



13.2 l/m
3.5 USGPM



max 105 BAR
1500 P.S.I.

APPLICAZIONI - APPLICATIONS



MANUTENZIONE
MAINTENANCE



PROCESSI INDUSTRIALI
INDUSTRIAL PROCESSES



AUTOLAVAGGIO
CARWASH



EDILIZIA
CONSTRUCTION



SANIFICAZIONE
SANITIZATION

TECHNICAL PLUS:



USCITA ALBERO DX
RIGHT DRIVE SHAFT



CARTER REVERSIBILE, PER USCITA ALBERO SX O DX
REVERSIBLE CRANKCASE FOR LEFT OR RIGHT



BIELLE IN LEGA TONOLLI 328
CONRODS IN HYPER 328 TONOLLI ALLOY



GUARNIZIONI TENUTA ACQUA NBR (BUNA)
NBR (BUNA) WATER SEALS

OPTIONAL:



USCITA ALBERO LATO SX
LEFT DRIVE SHAFT



BIELLE IN BRONZO
BRONZE CONRODS

GUARNIZIONI - SEALS



GUARNIZIONI ANTERIORI
"V" - POSTERIORI "U"
"V" FRONT SEALS - "U" BACK SEALS

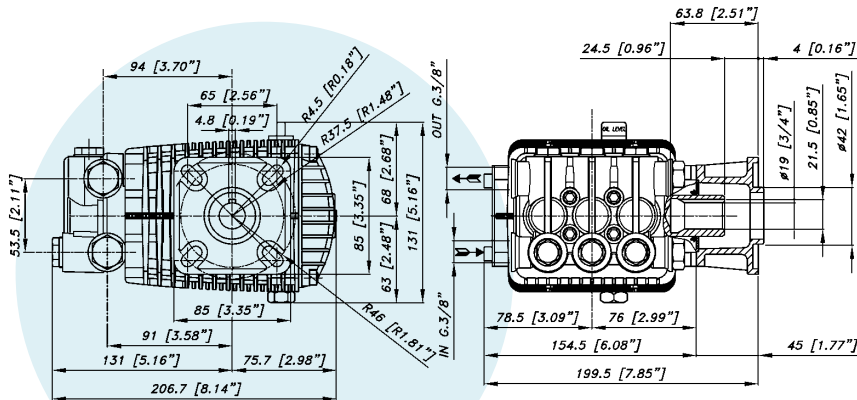

CARATTERISTICHE TECNICHE SPECIFICATIONS

Peso - Weight	6 Kg	13.2 lb
IN	3/8 BSP	
Pressione Min - Min Pressure	1 BAR	15 P.S.I.
Pressione Max - Max Pressure	6 BAR	87 P.S.I.
OUT	3/8 BSP	
Albero - Shaft	HOLLOW Ø 3/4"	
Max. Temperatura - Max. Temperature	60 °C	140 °F
Tipo olio - Oil type	SAE 75 - W 90	
Capacità olio - Oil capacity	0,5 lt	0.13 U.S.G.
Predisposta per motore - For Engine	SAE J609-3/4"	

WBG Series
WBG 1535



13.2 l/m
 3.5 USGPM



max 105 BAR
 1500 P.S.I.

CODICE CODE	MODELLO MODEL	Press. Max Max Pres.		RPM 3450					Pist. Plung.	Corsa Stroke
				Portata-Flow		Potenza-Power				
		BAR	P.S.I.	L/min	GPM	KW	HP	HP Engine	Dia. mm	mm
02.6150.97.3	WBG 1521	105	1500	8	2,1	1,6	2,1	3,5	15	4,8
02.6151.97.3	WBG 2021	140	2000	8	2,1	2,1	2,8	4	15	4,8
02.6152.97.3	WBG 2521	175	2500	8	2,1	2,6	3,5	5	15	4,8
02.6153.97.3	WBG 1625	110	1600	9,5	2,5	2,1	2,8	4	15	6
02.6154.97.3	WBG 2025	140	2000	9,5	2,5	2,6	3,5	5	15	6
02.6155.97.3	WBG 2525	175	2500	9,5	2,5	3,2	4,3	6	15	6
02.6156.97.3	WBG 1630	110	1600	11,4	3	2,5	3,4	5	15	7,2
02.6157.97.3	WBG 2030	140	2000	11,4	3	3,1	4,2	5,5	15	7,2
02.6158.97.3	WBG 2530	175	2500	11,4	3	3,8	5,1	6,5	15	7,2
02.6159.97.3	WBG 1535	105	1500	13,2	3,5	2,6	3,5	5	15	8
02.6160.97.3	WBG 2035	140	2000	13,2	3,5	3,5	4,7	6,5	15	8
02.6161.97.3	WBG 2535	175	2500	13,2	3,5	4,3	5,8	6,5	15	8