

WML/WML-F Series

WML 1214



12 l/m
3.2 USGPM



max 140 BAR
2000 P.S.I.

APPLICAZIONI - APPLICATIONS



MANUTENZIONE
MAINTENANCE



PROCESSI INDUSTRIALI
INDUSTRIAL PROCESSES



AUTOLAVAGGIO
CARWASH



EDILIZIA
CONSTRUCTION



SANIFICAZIONE
SANITIZATION

TECHNICAL PLUS:



USCITA ALBERO DX
RIGHT DRIVE SHAFT



BIELLE IN LEGA TONOLLI 328
CONRODS IN HYPER 328 TONOLLI ALLOY



GUARNIZIONI TENUTA ACQUA NBR (BUNA)
NBR (BUNA) WATER SEALS

GUARNIZIONI - SEALS

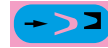

GUARNIZIONI ANTERIORI
"V" - POSTERIORI "U"
"V" FRONT SEALS - "U" BACK SEALS

OPTIONAL:



USCITA ALBERO LATO SX
LEFT DRIVE SHAFT



BIELLE IN BRONZO
BRONZE CONRODS



KIT PIEDINI IN LAMIERA D'ACCIAIO ZINCATI
GALVANIZED STEEL MOUNTING RAILS KIT



RIDUTTORE PER MOTORE TERMICO
GEARBOX FOR GAS/DIESEL ENGINE

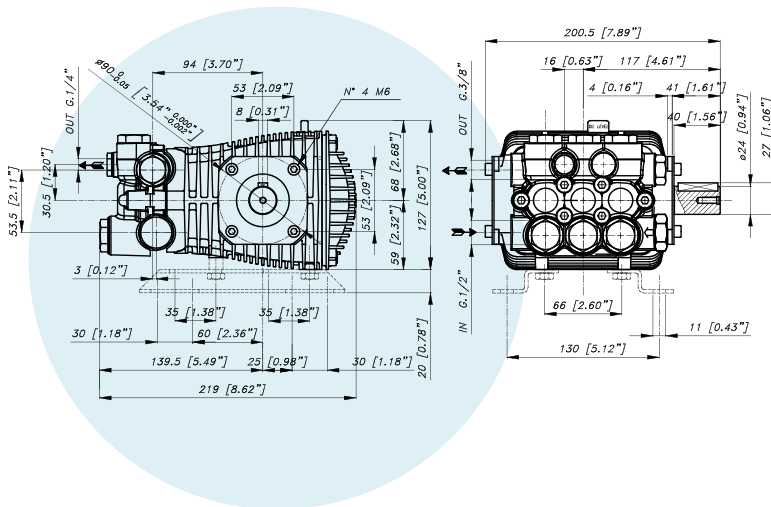

CARATTERISTICHE TECNICHE SPECIFICATIONS

Peso - Weight	7 Kg	14,4 lb
IN	1/2 BSP	
Pressione Min - Min Pressure	-0,1 BAR	-1.5 P.S.I.
Pressione Max - Max Pressure	6 BAR	87 P.S.I.
OUT	3/8 BSP	
Albero - Shaft	Ø 24 mm	
Max. Temperatura - Max. Temperature	60 °C	140 °F
Tipo olio - Oil type	SAE 75 - W 90	
Capacità olio - Oil capacity	0,6 lt	0.16 U.S.G.

12 l/m
3.2 USGPMmax 140 BAR
2000 P.S.I.

CODICE CODE	MODELLO MODEL	Press. Max Max Pres.		RPM 1450				Pist. Plung.	Corsa Stroke
				Portata-Flow		Potenza-Power			
		BAR	P.S.I.	L/min	GPM	KW	HP	Dia. mm	mm
04.8000.97.3	WML 1117	170	2500	11	2,9	3,3	4,5	18	9,8
04.8001.97.3	WML 1214	140	2000	12	3,2	2,9	4	18	10,8
04.8002.97.3	WML 1217	170	2500	12	3,2	3,6	5	18	10,8
04.8003.97.3	WML 1317	170	2500	13	3,4	4	5,5	18	12,4
04.8004.97.3	WML 1515	150	2200	15	4	4	5,5	18	13,6
04.8009.97.3	WML 1520-B	200	2900	15	4	5,5	7,4	18	13,6