

WML/WML-F Series

WML 1120-F



11 l/m
2.9 USGPM



max 200 BAR
2900 P.S.I.

APPLICAZIONI - APPLICATIONS



MANUTENZIONE
MAINTENANCE



PROCESSI INDUSTRIALI
INDUSTRIAL PROCESSES



AUTOLAVAGGIO
CARWASH



EDILIZIA
CONSTRUCTION



SANIFICAZIONE
SANITIZATION

TECHNICAL PLUS:



USCITA ALBERO DX
RIGHT DRIVE SHAFT



BIELLE IN BRONZO
BRONZE CONRODS



GUARNIZIONI TENUTA ACQUA NBR (BUNA)
NBR | BUNA | WATER SEALS

OPTIONAL:



USCITA ALBERO LATO SX
LEFT DRIVE SHAFT



KIT PIEDINI IN LAMIERA D'ACCIAIO ZINCATI
GALVANIZED STEEL MOUNTING RAILS KIT



RIDUTTORE PER MOTORE TERMICO
GEARBOX FOR GAS/DIESEL ENGINE

GUARNIZIONI - SEALS



GUARNIZIONI ANTERIORI
"V" - POSTERIORI "U"
"V" FRONT SEALS - "U" BACK SEALS

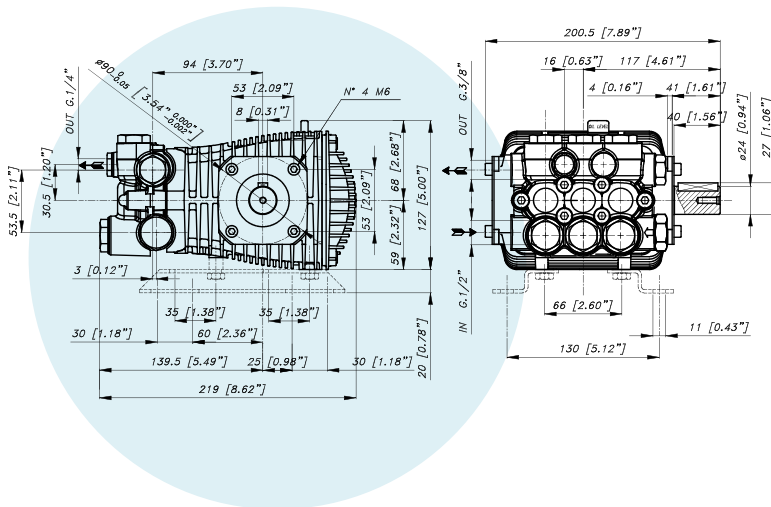

CARATTERISTICHE TECNICHE SPECIFICATIONS

Peso - Weight	7 Kg	14.4 lb
IN	1/2 BSP	
Pressione Min - Min Pressure	1 BAR	15 P.S.I.
Pressione Max - Max Pressure	6 BAR	87 P.S.I.
OUT	3/8 BSP	
Albero - Shaft	Ø 24 mm	
Max. Temperatura - Max. Temperature	60 °C	140 °F
Tipo olio - Oil type	SAE 75 - W 90	
Capacità olio - Oil capacity	0,6 lt	0.16 U.S.G.

WML/WML-F Series
WML 1120-F



11 l/m
2.9 USGPM



max 200 BAR
2900 P.S.I.

CODICE CODE	MODELLO MODEL	Press. Max Max Pres.		RPM 2800				Pist. Plung.	Corsa Stroke
				Portata-Flow		Potenza-Power			
		BAR	P.S.I.	L/min	GPM	KW	HP	Dia. mm	mm
04.8100.97.3	WML 1114-F	140	2000	11	2,9	2,9	4	15	8
04.8101.97.3	WML 1117-F	170	2500	11	2,9	3,6	5	15	8
04.8102.97.3	WML 1120-F	200	2900	11	2,9	4	5,5	15	8
04.8103.97.3	WML 1316-F	160	2350	13	3,4	4	5,5	15	9,8
04.8104.97.3	WML 1320-F	200	2900	13	3,4	5,1	7	15	9,8
04.8105.97.3	WML 1515-F	150	2200	15	4	4	5,5	15	10,8
04.8106.97.3	WML 1520-F	200	2900	15	4	5,5	7,5	15	10,8