

# TML HP Series

## TML 1728-HP



17 l/m  
4.5 USGPM



max 280 BAR  
4060 P.S.I.

### APPLICAZIONI - APPLICATIONS



MANUTENZIONE  
MAINTENANCE



PROCESSI INDUSTRIALI  
INDUSTRIAL PROCESSES



AUTOLAVAGGIO  
CARWASH



EDILIZIA  
CONSTRUCTION



SANIFICAZIONE  
SANITIZATION

### TECHNICAL PLUS:



USCITA ALBERO DX  
RIGHT DRIVE SHAFT



CARTER REVERSIBILE, PER USCITA ALBERO SX O DX  
REVERSIBLE CRANKCASE FOR LEFT OR RIGHT



BIELLE IN BRONZO  
BRONZE CONRODS



GUARNIZIONI TENUTA ACQUA NBR (BUNA)  
NBR (BUNA) WATER SEALS

### SPECIAL TRADEMARK:



INTELLIseal™



INTELLIseal H-W™

### OPTIONAL:



USCITA ALBERO LATO SX  
LEFT DRIVE SHAFT



RIDUTTORE PER MOTORE TERMICO  
GEARBOX FOR GAS/DIESEL ENGINE



FLANGIA E GIUNTO ELASTICO PER MOTORE  
ELETTRICO B3 - B14  
BELL HOUSING AND FLEXIBLE COUPLING  
FOR ELECTRIC MOTOR B3 - B14



KIT PIEDINI IN LAMIERA  
D'ACCIAIO ZINCATI  
GALVANIZED STEEL  
MOUNTING RAILS KIT

### GUARNIZIONI - SEALS



GUARNIZIONI ANTERIORI SUPER "U"  
GUARNIZIONI POSTERIORI "V"  
SUPER "U" FRONT SEALS - "V" BACK SEALS

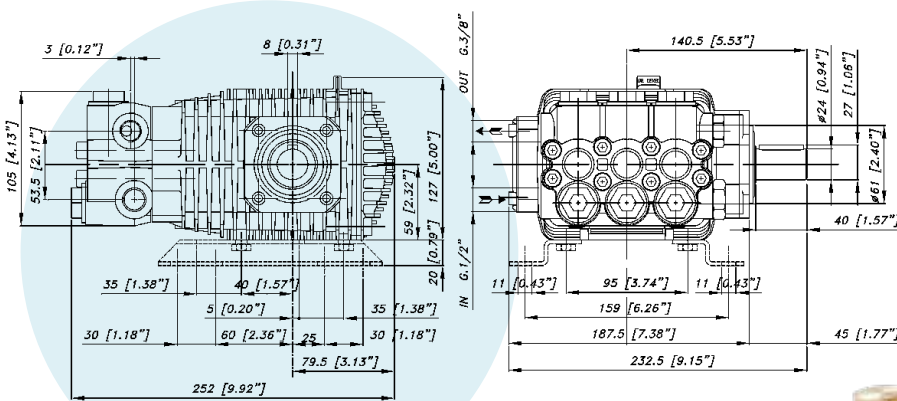

### CARATTERISTICHE TECNICHE SPECIFICATIONS

<b>Peso - Weight</b>	<b>10 Kg</b>	22 lb
<b>IN</b>	<b>1/2 BSP</b>	
<b>Pressione Min - Min Pressure</b>	<b>-0,1 BAR</b>	-1.5 P.S.I.
<b>Pressione Max - Max Pressure</b>	<b>6 BAR</b>	87 P.S.I.
<b>OUT</b>	<b>3/8 BSP</b>	
<b>Albero - Shaft</b>	<b>Ø 24 mm</b>	
<b>Max. Temperatura - Max. Temperature</b>	<b>74 °C</b>	165 °F
<b>Tipo olio - Oil type</b>	<b>SAE 75 - W 90</b>	
<b>Capacità olio - Oil capacity</b>	<b>0,7 lt</b>	0.18 U.S.G.

17 l/m  
4.5 USGPMmax 280 BAR  
4060 P.S.I.

CODICE CODE	MODELLO MODEL	Press. Max Max Pres.		RPM 950				RPM 1450				RPM 1725				Pist. Plung.	Corsa Stroke
				Portata-Flow		Potenza-Power		Portata-Flow		Potenza-Power		Portata-Flow		Potenza-Power			
		BAR	P.S.I.	L/min	GPM	KW	HP	L/min	GPM	KW	HP	L/min	GPM	KW	HP	Dia. mm	mm
07.1051.97.3	TML 1328-HP	280	4060	8	2,1	4,6	6,2	13	3,4	7,0	9,4	15	4,0	8,2	11,0	18	12,4
07.1052.97.3	TML 1528-HP	280	4060	10	2,6	5,3	7,1	15	4,0	8,1	10,9	17	4,5	9,5	12,7	18	14,4
07.1053.97.3	TML 1728-HP	280	4060	11	2,9	5,9	7,9	17	4,5	9,2	12,4	19	5,0	10,5	14,1	18	16
07.1054.97.3	TML 2028-HP	280	4060	13	3,4	6,9	9,3	20	5,3	10,9	14,6	23	6,1	12,3	16,5	18	18,7