

TMG 1" Series

TMG 3540



15 l/m
4.0 USGPM



max 240 BAR
3500 P.S.I.

APPLICAZIONI - APPLICATIONS



MANUTENZIONE
MAINTENANCE



PROCESSI INDUSTRIALI
INDUSTRIAL PROCESSES



AUTOLAVAGGIO
CARWASH



EDILIZIA
CONSTRUCTION



SANIFICAZIONE
SANITIZATION

TECHNICAL PLUS:



USCITA ALBERO DX
RIGHT DRIVE SHAFT



CARTER REVERSIBILE, PER USCITA ALBERO SX O DX
REVERSIBLE CRANKCASE FOR LEFT OR RIGHT



BIELLE IN BRONZO
BRONZE CONRODS

OPTIONAL:



USCITA ALBERO LATO SX
LEFT DRIVE SHAFT

GUARNIZIONI - SEALS



GUARNIZIONI ANTERIORI "V"
POSTERIORI "U"
"V" FRONT SEALS - "U" BACK SEALS

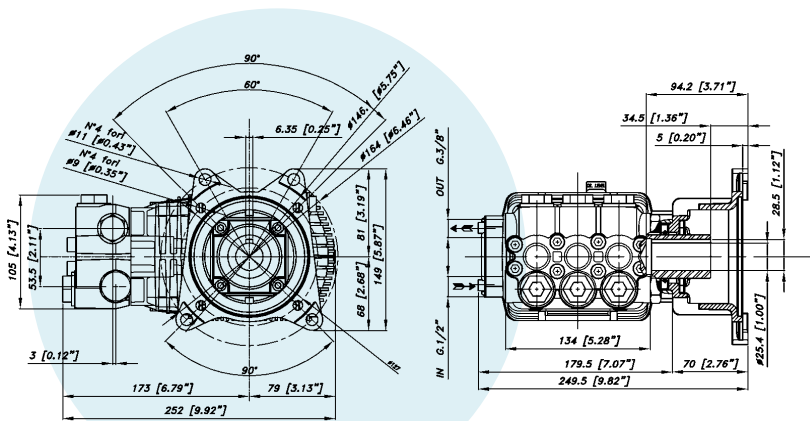

CARATTERISTICHE TECNICHE SPECIFICATIONS

Peso - Weight	10,8 Kg	23.7 lb
IN	1/2 BSP	
Pressione Min - Min Pressure	1 BAR	15 P.S.I.
Pressione Max - Max Pressure	6 BAR	87 P.S.I.
OUT	3/8 BSP	
Albero - Shaft	HOLLOW Ø 1"	
Max. Temperatura - Max. Temperature	60 °C	140 °F
Tipo olio - Oil type	SAE 75 - W 90	
Capacità olio - Oil capacity	0,7 lt	0.18 U.S.G.
Predisposta per motore - For motor	SAE J609 -1"	

TMG 1" Series
TMG 3540



15 l/m
4.0 USGPM



max 240 BAR
3500 P.S.I.

CODICE CODE	MODELLO MODEL	Press. Max Max Pres.		RPM 3450					Pist. Plung.	Corsa Stroke
				Portata-Flow		Potenza-Power				
		BAR	P.S.I.	L/min	GPM	KW	HP	HP ENGINE	Dia. mm	mm
07.1600.97.A	TMG 3535	240	3500	13	3,4	6,3	8,5	11	15	8,6
07.1601.97.A	TMG 4035	280	4000	13	3,4	7	9,5	13	15	8,6
07.1602.97.A	TMG 3540	240	3500	15	4,0	7	9,6	13	15	9,8
07.1603.97.A	TMG 4040	280	4000	15	4,0	8,1	11	14,5	15	9,8
07.1604.97.A	TMG 3545	240	3500	17	4,5	6	8,1	14	15	11,2
07.1605.97.A	TMG 4045	280	4000	17	4,5	9,2	12,5	16	15	11,2
07.1606.97.A	TMG 3550	240	3500	19	5,0	8,8	12	16	15	12,4
07.1607.97.A	TMG 4050	280	4000	19	5,0	9,9	13,5	18	15	12,4
07.1608.97.A	TMG 3555	240	3500	21	5,5	9,9	13,5	18	15	14