

TAM 316 Series TAM 2015



20 l/m
5.3 USGPM



max 150 BAR
2175 P.S.I.

APPLICAZIONI - APPLICATIONS



ANTINCENDIO
FIRE PREVENTION



PROCESSI INDUSTRIALI
INDUSTRIAL PROCESSES



IND. ALIMENTARE
FOOD INDUSTRY



AUTOLAVAGGIO
CARWASH



INSTALLAZIONI NAVALI
NAVAL INSTALLATIONS



SPURGO
PURGING



INSTALLAZIONI AEROPORTUALI
AIRPORT INSTALLATIONS



PULIZIA STRADALE
STREET CLEANING



INDUSTRIA CHIMICA
CHEMICAL INDUSTRY



EDILIZIA
CONSTRUCTION



INDUSTRIA FARMACEUTICA
PHARMACEUTICAL INDUSTRY

TECHNICAL PLUS:



USCITA ALBERO DX
RIGHT DRIVE SHAFT



CARTER REVERSIBILE, PER USCITA ALBERO SX O DX
REVERSIBLE CRANKCASE FOR LEFT OR RIGHT



BIELLE IN LEGA TONOLLI 328
CONRODS IN HYPER 328 TONOLLI ALLOY



GUARNIZIONI TENUTA ACQUA NBR (BUNA)
NBR (BUNA) WATER SEALS



CORPO POMPA IN ACCIAIO INOX
STAINLESS STEEL PUMP HEAD

SPECIAL TRADEMARK:



INTELLIseal™

OPTIONAL:



BIELLE IN BRONZO
BRONZE CONRODS

GUARNIZIONI - SEALS



GUARNIZIONI ANT. SUPER "U"
POSTERIORI "U" (PTFE) TEMP.
ACQUA 85°C - 185°F
SUPER "U" FRONT SEALS
PTFE "U" BACK SEALS FOR
WATER TEMPERATURE 85°C - 185°F

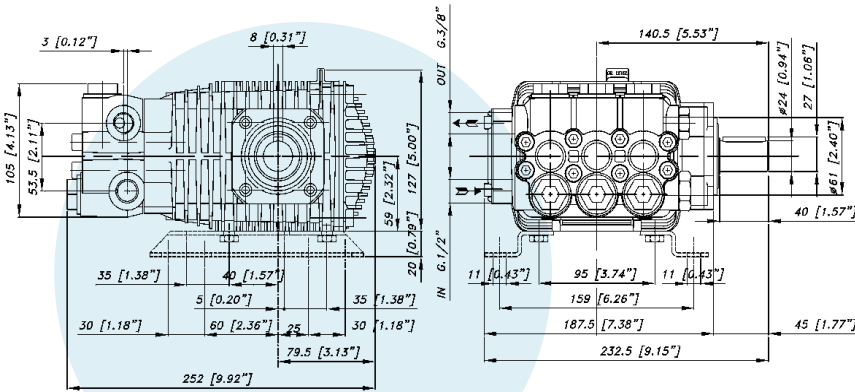

testa in acciaio aisi 316



CARATTERISTICHE TECNICHE SPECIFICATIONS

Peso - Weight	10,6 Kg	23.3 lb
IN	1/2 BSP	
Pressione Min - Min Pressure	-0,1 BAR	-1.5 P.S.I.
Pressione Max - Max Pressure	6 BAR	87 P.S.I.
OUT	3/8 BSP	
Albero - Shaft	Ø 24 mm	
Max. Temperatura - Max. Temperature	85 °C	185 °F
Tipo olio - Oil type	SAE 75 - W 90	
Capacità olio - Oil capacity	0,7 lt	0.18 U.S.G.

TAM 316 Series

TAM 2015



20 L/m
5.3 USGPM



max 150 BAR
2175 P.S.I.

CODICE CODE	MODELLO MODEL	Press. Max Max Pres.		RPM 950				RPM 1450				RPM 1725				Pist. Plung.	Corsa Stroke
				Portata-Flow		Portata-Flow		Portata-Flow		Potenza-Power		Portata-Flow		Potenza-Power			
		BAR	P.S.I.	L/min	GPM	KW	HP	L/min	GPM	KW	HP	L/min	GPM	KW	HP		
07.1018.97.A	TAM 1215	150	2175	8	2,1	2,3	3,1	12	3,2	3,4	4,6	14	3,7	4,0	5,4	18	11,2
07.1024.97.A	TAM 1315	150	2175	9	2,4	2,5	3,4	13	3,4	3,8	5,1	15	4,0	4,5	6,0	18	12,4
07.1025.97.A	TAM 1515	150	2175	10	2,6	2,9	3,9	15	4,0	4,4	5,9	18	4,8	5,2	7,0	18	14,4
07.1026.97.A	TAM 1715	150	2175	11	2,9	3,2	4,3	17	4,5	4,9	6,6	20	5,3	5,8	7,8	18	16
07.1027.97.A	TAM 2015	150	2175	13	3,4	3,8	5,1	20	5,3	5,7	7,6	23	6,1	6,7	9,0	18	18,7

GRAFICO PRESTAZIONI PERFORMANCE CHART

