

RX 400 Series

RX 3540



35 l/m
9.2 USGPM



max 400 BAR
5800 P.S.I.

APPLICAZIONI - APPLICATIONS



MANUTENZIONE
MAINTENANCE



PROCESSI INDUSTRIALI
INDUSTRIAL PROCESSES



AUTOLAVAGGIO
CARWASH



EDILIZIA
CONSTRUCTION



SANIFICAZIONE
SANITIZATION



IMPIANTI DI VERNICIATURA
PAINTING PLANTS



LAVAGGI
WASHING

TECHNICAL PLUS:



USCITA ALBERO DX
RIGHT DRIVE SHAFT



PISTONE IN CERAMICA GRANDE SPESSORE PER ACQUA CALDA
INCREASED THICKNESS OF CERAMIC PISTON FOR HOT WATER USE



GUARNIZIONI TENUTA ACQUA NBR (BUNA)
NBR (BUNA) WATER SEALS



BIELLE IN BRONZO
BRONZE CONRODS

SPECIAL TRADEMARK:



INTELLiseal™

OPTIONAL:



USCITA ALBERO LATO SX
LEFT DRIVE SHAFT



FLANGIA E GIUNTO ELASTICO PER MOTORE
ELETTRICO B3 - B14
BELL HOUSING AND FLEXIBLE COUPLING
FOR ELECTRIC MOTOR B3 - B14



KIT PIEDINI IN LAMIERA D'ACCIAIO ZINCATI
GALVANIZED STEEL MOUNTING RAILS KIT

GUARNIZIONI - SEALS



GUARNIZIONI ANTERIORI SUPER "U"
POSTERIORI "U"
SUPER "U" FRONT SEALS - "U" BACK SEALS

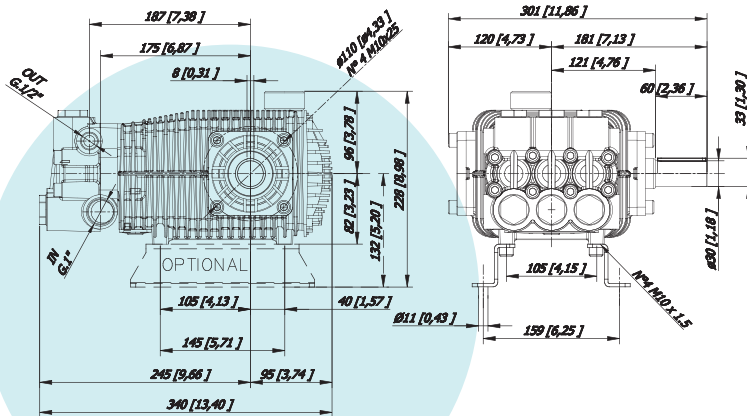

CARATTERISTICHE TECNICHE SPECIFICATIONS

Peso - Weight	23,0 Kg	50.7 lb
IN	1" BSP	
Pressione Min - Min Pressure	-0,1 BAR	-1.5 P.S.I.
Pressione Max - Max Pressure	6 BAR	87 P.S.I.
OUT	1/2 BSP	
Albero - Shaft	Ø 30 mm	
Max. Temperatura - Max. Temperature	74 °C	165 °F
Tipo olio - Oil type	SAE 75 - W 90	
Capacità olio - Oil capacity	1,5 lt	0.4 U.S.G.

RX 400 Series

RX 3540



35 L/m
9.2 USGPM



max 400 BAR
5800 P.S.I.

CODICE CODE	MODELLO MODEL	Press. Max Max Pres.		RPM 950				RPM 1200				RPM 1450				Pist. Plung.	Corsa Stroke
				Portata-Flow		Portata-Flow		Portata-Flow		Potenza-Power		Portata-Flow		Potenza-Power			
		BAR	P.S.I.	L/min	GPM	KW	HP	L/min	GPM	KW	HP	L/min	GPM	KW	HP		
18.2003.97.3	RX 2340	400	5800	15	4,0	11,6	15,6	19	5,0	14,5	19,5	22	5,8	17,4	23,3	22	14,4
18.2002.97.3	RX 2840	400	5800	18	4,8	14,1	18,9	23	6,1	17,7	23,7	27	7,1	21,1	28,3	22	17,5
18.2001.97.3	RX 3540	400	5800	24	6,3	18,4	24,6	29	7,7	23,0	30,8	35	9,2	27,5	36,8	22	23
18.2007.97.3	RX 3840	400	5800	25	6,6	19,7	26,5	32	8,5	24,7	33,1	38	10,0	29,5	39,6	22	25

GRAFICO PRESTAZIONI PERFORMANCE CHART

