

# RX 500 Series RX 3250



32 l/m  
8.4 USGPM



max 500 BAR  
7250 P.S.I.

## APPLICAZIONI - APPLICATIONS



MANUTENZIONE  
MAINTENANCE



PROCESSI INDUSTRIALI  
INDUSTRIAL PROCESSES



AUTOLAVAGGIO  
CARWASH



EDILIZIA  
CONSTRUCTION



SANIFICAZIONE  
SANITIZATION



IMPIANTI DI VERNICIATURA  
PAINTING PLANTS



LAVAGGI  
WASHING

## TECHNICAL PLUS:



USCITA ALBERO DX  
RIGHT DRIVE SHAFT



PISTONE IN CERAMICA GRANDE SPESSORE PER ACQUA CALDA  
INCREASED THICKNESS OF CERAMIC PISTON FOR HOT WATER USE



GUARNIZIONI TENUTA ACQUA NBR (BUNA)  
NBR (BUNA) WATER SEALS



BIELLE IN BRONZO  
BRONZE CONRODS

## SPECIAL TRADEMARK:



INTELLIseal™

## OPTIONAL:



USCITA ALBERO LATO SX  
LEFT DRIVE SHAFT



FLANGIA E GIUNTO ELASTICO PER MOTORE  
ELETTRICO B3 - B14  
BELL HOUSING AND FLEXIBLE COUPLING  
FOR ELECTRIC MOTOR B3 - B14



KIT PIEDINI IN LAMIERA D'ACCIAIO ZINCATO  
GALVANIZED STEEL MOUNTING RAILS KIT

## GUARNIZIONI - SEALS

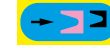

GUARNIZIONI ANTERIORI SUPER "U"  
POSTERIORI "U"  
SUPER "U" FRONT SEALS - "U" BACK SEALS

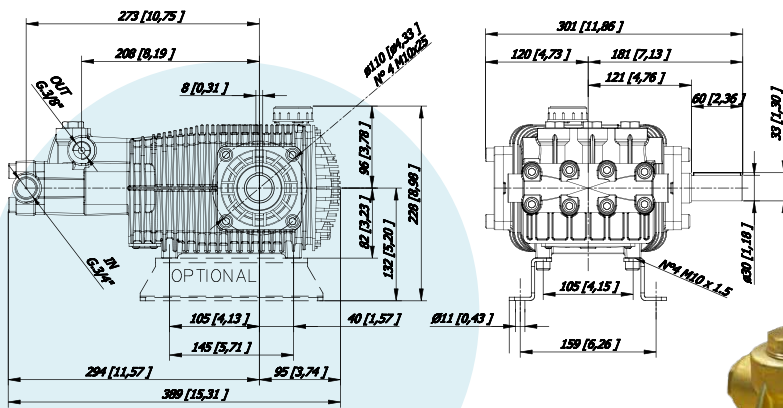

## CARATTERISTICHE TECNICHE SPECIFICATIONS

<b>Peso - Weight</b>	<b>23.0 Kg</b>	50.7 lb
<b>IN</b>	<b>3/4 BSP</b>	
<b>Pressione Min - Min Pressure</b>	<b>-0.1 BAR</b>	-1.5 P.S.I.
<b>Pressione Max - Max Pressure</b>	<b>6 BAR</b>	87 P.S.I.
<b>OUT</b>	<b>3/8 BSP</b>	
<b>Albero - Shaft</b>	<b>Ø 30 mm</b>	
<b>Max. Temperatura - Max. Temperature</b>	<b>74 °C</b>	165 °F
<b>Tipo olio - Oil type</b>	<b>SAE 75 - W 90</b>	
<b>Capacità olio - Oil capacity</b>	<b>1,5 lt</b>	0.4 U.S.G.

# RX 500 Series

## RX 3250



32 l/m  
8.4 USGPM



max 500 BAR  
7250 P.S.I.

CODICE CODE	MODELLO MODEL	Press. Max Max Pres.		RPM 950				RPM 1200				RPM 1450				Pist. Plung.	Corsa Stroke
				Portata-Flow		Portata-Flow		Portata-Flow		Potenza-Power		Portata-Flow		Potenza-Power			
		BAR	P.S.I.	L/min	GPM	KW	HP	L/min	GPM	KW	HP	L/min	GPM	KW	HP		
18.2005.97.3	RX 1950	500	7250	12	3,2	12,0	16,1	15	4,0	15,0	20,1	19	4,8	18,0	24,1	20	14,4
18.2004.97.3	RX 2350	500	7250	15	3,9	14,6	19,6	19	4,9	18,2	24,5	22	5,9	21,8	29,3	20	17,5
18.2000.97.3	RX 3050	500	7250	20	5,2	19,4	26,0	25	6,5	24,2	32,5	30	7,8	29,0	38,9	20	23
18.2006.97.3	RX 3250	500	7250	21	5,6	20,8	27,9	27	7,0	26,1	34,9	32	8,4	31,2	41,8	20	25

### GRAFICO PRESTAZIONI PERFORMANCE CHART

