

RB Premium Series

RB 1719-P



17 l/m
4.5 USGPM



max 190 BAR
2755 P.S.I.

APPLICAZIONI - APPLICATIONS



MANUTENZIONE
MAINTENANCE



PROCESSI INDUSTRIALI
INDUSTRIAL PROCESSES



AUTOLAVAGGIO
CARWASH



EDILIZIA
CONSTRUCTION



SANIFICAZIONE
SANITIZATION



IMPIANTI DI VERNICIATURA
PAINTING PLANTS



LAVAGGI
WASHING

TECHNICAL PLUS:



USCITA ALBERO DX
RIGHT DRIVE SHAFT



KIT PIEDINI IN LAMIERA D'ACCIAIO ZINCATI
GALVANIZED STEEL MOUNTING RAILS KIT



BIELLE IN BRONZO
BRONZE CONRODS



PISTONE IN CERAMICA GRANDE SPESSORE PER ACQUA CALDA
INCREASED THICKNESS OF CERAMIC PISTON FOR HOT WATER USE



GUARNIZIONI TENUTA ACQUA NBR (BUNA)
NBR (BUNA) WATER SEALS

SPECIAL TRADEMARK:



INTELLIseal™

OPTIONAL:



USCITA ALBERO LATO SX
LEFT DRIVE SHAFT

GUARNIZIONI - SEALS

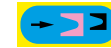

GUARNIZIONI ANTERIORI SUPER "U"
POSTERIORI "U"
SUPER "U" FRONT SEALS - "U" BACK SEALS

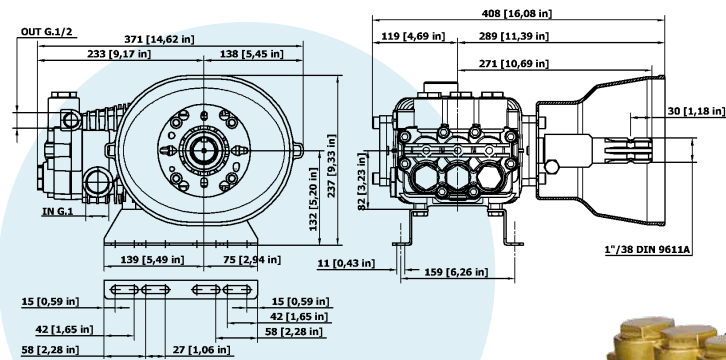

CARATTERISTICHE TECNICHE SPECIFICATIONS

Peso - Weight	22 Kg	48.5 lb
IN	1" BSP	
Pressione Min - Min Pressure	-0,1 BAR	-1.5 P.S.I.
Pressione Max - Max Pressure	6 BAR	87 P.S.I.
OUT	1/2 BSP	
Albero - Shaft	1" 3/8 DIN 9611A	
Max. Temperatura - Max. Temperature	74 °C	165 °F
Tipo olio - Oil type	SAE 75 - W 90	
Capacità olio - Oil capacity	1,5 lt	0.4 U.S.G.

RB Premium Series

RB 1719-P

	17 l/m 4.5 USGPM		max 190 BAR 2755 P.S.I.
---	---------------------	---	----------------------------

CODICE CODE	MODELLO MODEL	Press. Max Max Pres.		RPM 950				RPM 750				RPM 1000				Pist. Plung.	Corsa Stroke
				Portata-Flow		Portata-Flow		Portata-Flow		Potenza-Power		Portata-Flow		Potenza-Power			
		BAR	P.S.I.	L/min	GPM	KW	HP	L/min	GPM	KW	HP	L/min	GPM	KW	HP		
08.1010.97.A	RB 1719-P	190	2755	17	4,5	6,2	8,3	23	6,1	8,4	11,2	30	7,9	11,1	14,8	25	21
08.1011.97.A	RB 2019-P	190	2755	20	5,3	7,4	9,9	27	7,1	10,0	13,4	35	9,2	13,2	17,7	25	25

GRAFICO PRESTAZIONI PERFORMANCE CHART

