

RAL Premium Series

RAL 3030-P



29 l/m
7.7 USGPM



max 300 BAR
4350 P.S.I.

APPLICAZIONI - APPLICATIONS



MANUTENZIONE
MAINTENANCE



PROCESSI INDUSTRIALI
INDUSTRIAL PROCESSES



AUTOLAVAGGIO
CARWASH



EDILIZIA
CONSTRUCTION



SANIFICAZIONE
SANITIZATION



IMPIANTI DI VERNICIATURA
PAINTING PLANTS



LAVAGGI
WASHING

TECHNICAL PLUS:



USCITA ALBERO DX
RIGHT DRIVE SHAFT



PISTONE IN CERAMICA GRANDE SPESSORE PER ACQUA CALDA
INCREASED THICKNESS OF CERAMIC PISTON FOR HOT WATER USE



GUARNIZIONI TENUTA ACQUA NBR (BUNA)
NBR (BUNA) WATER SEALS



BIELLE IN BRONZO
BRONZE CONRODS

SPECIAL TRADEMARK:



INTELLIseal™

OPTIONAL:



USCITA ALBERO LATO SX
LEFT DRIVE SHAFT



RIDUTTORE PER MOTORE TERMICO
GEARBOX FOR GAS/DIESEL ENGINE



FLANGIA E GIUNTO ELASTICO PER MOTORE
ELETTRICO B3 - B14
BELL HOUSING AND FLEXIBLE COUPLING
FOR ELECTRIC MOTOR B3 - B14



KIT PIEDINI IN LAMIERA D'ACCIAIO ZINCATI
GALVANIZED STEEL MOUNTING RAILS KIT

GUARNIZIONI - SEALS

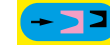

GUARNIZIONI ANTERIORI SUPER "U"
POSTERIORI "U"
SUPER "U" FRONT SEALS - "U" BACK SEALS

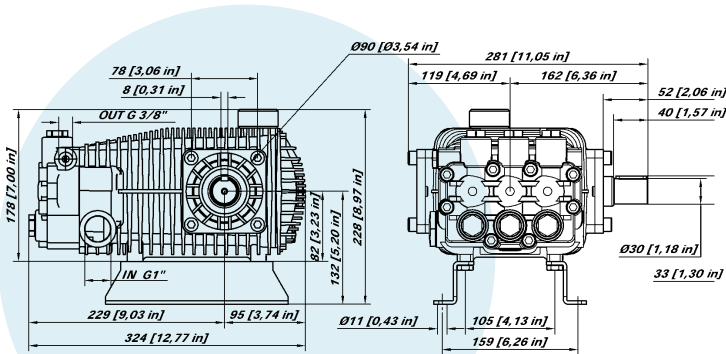

CARATTERISTICHE TECNICHE SPECIFICATIONS

Peso - Weight	19,5 Kg	43.0 lb
IN	1" BSP	
Pressione Min - Min Pressure	-0,1 BAR	-1.5 P.S.I.
Pressione Max - Max Pressure	6 BAR	87 P.S.I.
OUT	3/8 BSP	
Albero - Shaft	Ø 30 mm	
Max. Temperatura - Max. Temperature	74 °C	165 °F
Tipo olio - Oil type	SAE 75 - W 90	
Capacità olio - Oil capacity	1,5 lt	0.4 U.S.G.

RAL Premium Series

RAL 3030-P



29 L/m
7.7 USGPM



max 300 BAR
4350 P.S.I.

CODICE CODE	MODELLO MODEL	Press. Max Max Pres.		RPM 950				RPM 1450				RPM 1725				Pist. Plung.	Corsa Stroke
				Portata-Flow		Portata-Flow		Portata-Flow		Potenza-Power		Portata-Flow		Potenza-Power			
		BAR	P.S.I.	L/min	GPM	KW	HP	L/min	GPM	KW	HP	L/min	GPM	KW	HP	Dia. mm	mm
08.1019.97.A	RAL 1640-P	400	5800	11	2,9	8,5	11,5	17	4,5	12,9	17,3	20	5,3	15,2	20,4	18	16
08.1005.97.A	RAL 1840-P	400	5800	12	3,2	9,6	12,9	19	5,0	14,5	19,5	22	5,8	17,1	23,0	18	18
08.1021.97.A	RAL 2035-P	350	5075	14	3,7	9,2	12,4	20	5,3	14,0	18,7	24	6,3	16,4	22,0	20	16
08.1022.97.A	RAL 2335-P	350	5075	15	4,0	10,4	13,9	23	6,1	15,7	21,1	-	-	-	-	20	18

CODICE CODE	MODELLO MODEL	Press. Max Max Pres.		RPM 950				RPM 1200				RPM 1450				Pist. Plung.	Corsa Stroke
				Portata-Flow		Portata-Flow		Portata-Flow		Portata-Flow		Portata-Flow		Portata-Flow			
		BAR	P.S.I.	L/min	GPM	KW	HP	L/min	GPM	KW	HP	L/min	GPM	KW	HP	Dia. mm	mm
08.1000.97.A	RAL 2535-P	350	5075	17	4,5	11,3	15,1	21	5,5	14,1	18,9	25	6,6	16,8	22,6	20	19,5
08.1036.97.A	RAL 2830-P	300	4350	18	4,8	10,8	14,4	23	6,1	13,5	18,1	27	7,1	16,1	21,6	22	18
08.1002.97.A	RAL 3030-P	300	4350	20	5,3	11,5	15,5	25	6,6	14,4	19,4	29	7,7	17,3	23,2	22	19,5

GRAFICO PRESTAZIONI PERFORMANCE CHART

