

Power Unit CK 3003 PU CK 2216.1-100



63 l/m
16.6 USGPM



max 100 BAR
1450 P.S.I.

APPLICAZIONI - APPLICATIONS



ANTINCENDIO
FIRE PREVENTION



INSTALLAZIONI NAVALI
NAVAL INSTALLATIONS



PROCESSI INDUSTRIALI
INDUSTRIAL PROCESSES



INSTALLAZIONI AEREOPORTUALI
AIRPORT INSTALLATIONS

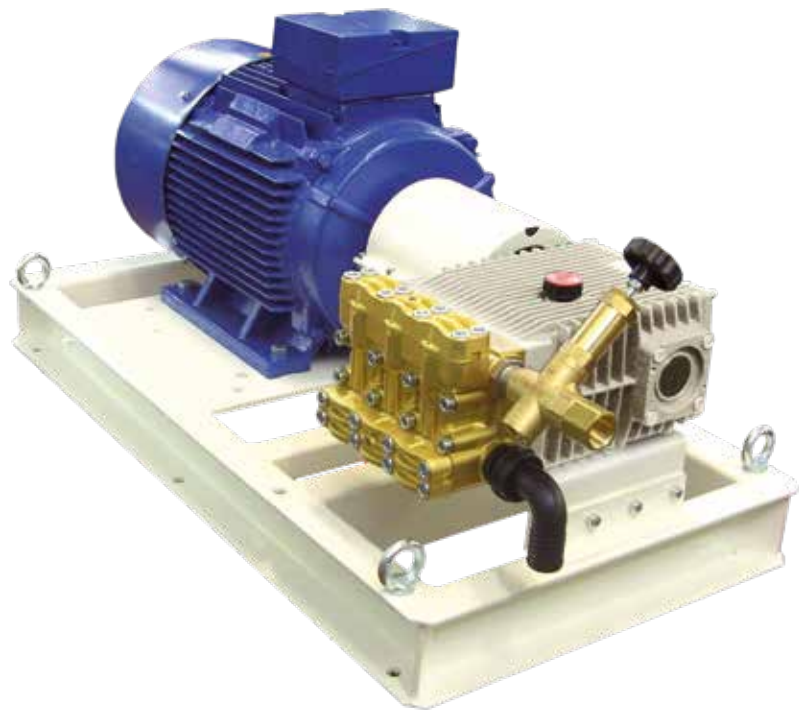
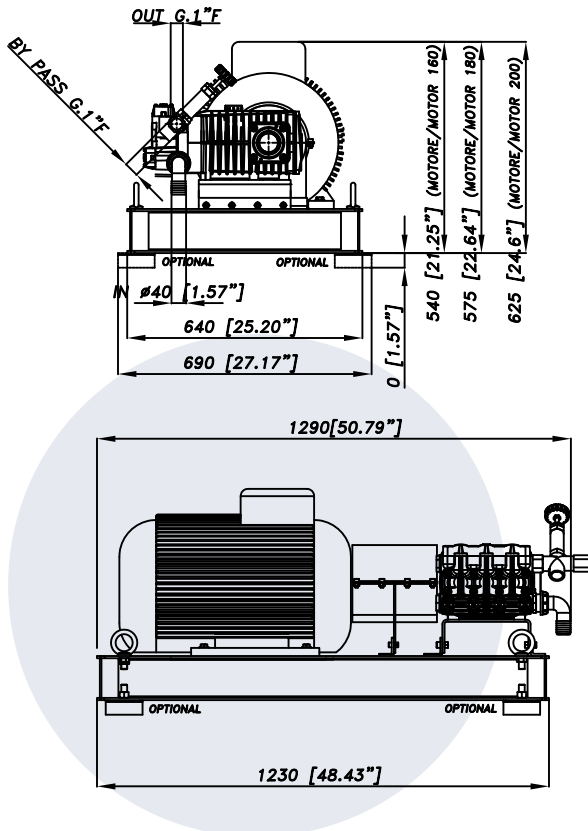

CARATTERISTICHE TECNICHE SPECIFICATIONS

Peso - Weight	65 Kg	143 lb
Misure - Size	1230x640mm	48.43"x25.20" in
IN	1" 1/2 BSP	
Pressione Min - Min Pressure	-0,2 BAR	-3 P.S.I.
Pressione Max - Max Pressure	6 BAR	87 P.S.I.
OUT	3/4 BSP	
Valvola fuori - Valve out	1" BSP	
Valvola by-pass - Valve by-pass	1" BSP	
Max. Temperatura - Max. Temperature	60 °C	140 °F
Tipo olio - Oil type	SAE 75 - W 90	
Capacità olio - Oil capacity	2,8 lt	0.74 U.S.G.

TABELLA RENDIMENTI
PERFORMANCE CHART

CODICI CODES			POMPA PUMP	MOTORE TRIFASE THREE-PHASE MOTOR			RPM	PRESSIONE PRESSURE		PORTATA FLOW		PESO GRUPPO COMPLETO POWER UNIT WEIGHT	
GRUPPO ELETTROPOMPA POWER UNIT (A)	BASAMENTO BASE (B)	GRUPPO COMPLETO COMPLETE POWER UNIT (A+B)		50Hz - 400V	kW	A		BAR	P.S.I.	L/min	GPM	Kg	LBS
73.9103.97.3	73.9502.97.3	73.9203.97.3	CK 2216.1	160L 4 POLI	15	29.5	1450	100	1450	63	16.6	270	594
73.9106.97.3	73.9500.97.3	73.9206.97.3	CK 2216.1	180L 4 POLI	22	42.0	1450	150	2175	63	16.6	326	717
73.9104.97.3	73.9500.97.3	73.9204.97.3	CK 2220.1	180M 4 POLI	18.5	35.0	1450	100	1450	80	21.1	312	686
73.9107.97.3	73.9501.97.3	73.9207.97.3	CK 2220.1	200L 4 POLI	30	56.6	1450	150	2175	80	21.1	382	840.4
73.9105.97.3	73.9500.97.3	73.9205.97.3	CKL 2226.1	180L 4 POLI	22	42.0	1450	100	1450	97	25.7	326	717
73.9108.97.3	73.9501.97.3	73.9208.97.3	CKL 2226.1	200L 4 POLI	30	56.6	1450	150	2175	97	25.7	382	840.4
73.9109.97.3	73.9501.97.3	73.9209.97.3	CKL 2233.1	200L 4 POLI	30	56.6	1450	120	1740	126	33.2	382	840.4
73.9100.97.3	73.9501.97.3	73.9200.97.3	CK 1224.1	200L 6 POLI	18.5	37.3	975	80	1160	97	25.7	371	816
73.9101.97.3	73.9501.97.3	73.9201.97.3	CK 1229.1	200L 6 POLI	22	43.9	975	80	1160	124	32.7	380	836
73.9102.97.3	73.9501.97.3	73.9202.97.3	CK 1235.1	200L 6 POLI	22	43.9	975	70	1015	150	39.7	380	836