

KA 316 Series KA 3215



33 l/m
8.7 USGPM



max 150 BAR
2175 P.S.I.

APPLICAZIONI - APPLICATIONS



ANTINCENDIO
FIRE PREVENTION



PROCESSI INDUSTRIALI
INDUSTRIAL PROCESSES



IND. ALIMENTARE
FOOD INDUSTRY



AUTOLAVAGGIO
CARWASH



INSTALLAZIONI NAVALI
NAVAL INSTALLATIONS



SPURGO
PURGING



INSTALLAZIONI AEROPORTUALI
AIRPORT INSTALLATIONS



PULIZIA STRADALE
STREET CLEANING



INDUSTRIA CHIMICA
CHEMICAL INDUSTRY



EDILIZIA
CONSTRUCTION



INDUSTRIA FARMACEUTICA
PHARMACEUTICAL INDUSTRY

TECHNICAL PLUS:



USCITA ALBERO DX
RIGHT DRIVE SHAFT



CARTER REVERSIBILE, PER USCITA ALBERO SX O DX
REVERSIBLE CRANKCASE FOR LEFT OR RIGHT



BIELLE IN LEGA TONOLLI 328
CONRODS IN HYPER 328 TONOLLI ALLOY



GUARNIZIONI TENUTA ACQUA NBR (BUNA)
NBR (BUNA) WATER SEALS



CORPO POMPA IN ACCIAIO INOX
STAINLESS STEEL PUMP HEAD

SPECIAL TRADEMARK:



INTELLIseal™

OPTIONAL:



USCITA ALBERO LATO SX
LEFT DRIVE SHAFT



RIDUTTORE PER MOTORE TERMICO
GEARBOX FOR GAS/DIESEL ENGINE



FLANGIA E GIUNTO ELASTICO PER MOTORE
ELETTRICO B3 - B14
BELL HOUSING AND FLEXIBLE COUPLING
FOR ELECTRIC MOTOR B3 - B14



KIT PIEDINI IN LAMIERA D'ACCIAIO ZINCATI
GALVANIZED STEEL MOUNTING RAILS KIT

GUARNIZIONI - SEALS

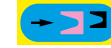

GUARNIZIONI ANTERIORI SUPER "U"
POSTERIORI "U"
SUPER "U" FRONT SEALS - "U" BACK SEALS

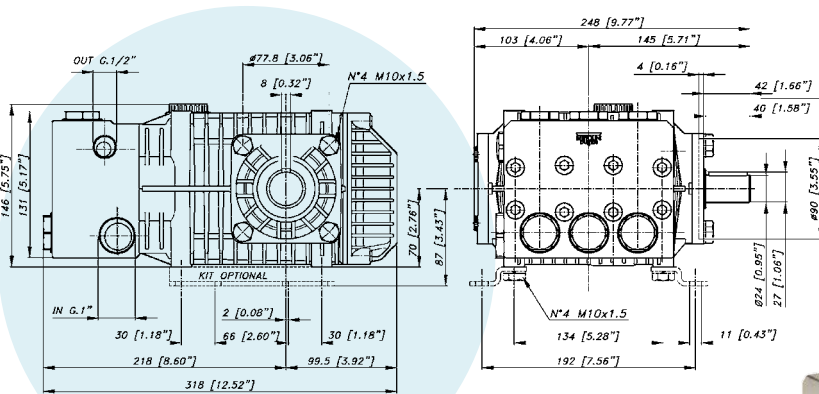

Testa in acciaio aisi 316



CARATTERISTICHE TECNICHE SPECIFICATIONS

Peso - Weight	19,3 Kg	42.5 lb
IN	1 BSP	
Pressione Min - Min Pressure	-0,1 BAR	-1.5 P.S.I.
Pressione Max - Max Pressure	6 BAR	87 P.S.I.
OUT	1/2 BSP	
Albero - Shaft	Ø 24 mm	
Max. Temperatura - Max. Temperature	74 °C	165 °F
Tipo olio - Oil type	SAE 75 - W 90	
Capacità olio - Oil capacity	1,4 lt	0.37 U.S.G.

KA 316 Series

KA 3215



33 l/m
8.7 USGPM



max 150 BAR
2175 P.S.I.

CODICE CODE	MODELLO MODEL	Press. Max Max Pres.		RPM 950				RPM 1450				RPM 1725				Pist. Plung.	Corsa Stroke
				Portata-Flow		Portata-Flow		Portata-Flow		Potenza-Power		Portata-Flow		Potenza-Power			
		BAR	P.S.I.	L/min	GPM	KW	HP	L/min	GPM	KW	HP	L/min	GPM	KW	HP		
06.4020.97.GU	KA 2815	150	2175	19	5,0	5,6	7,5	29	7,7	8,4	11,3	34	9,0	9,9	13,3	25	14,4
06.4021.97.GU	KA 3215	150	2175	22	5,8	6,3	8,4	33	8,7	9,6	12,9	38	10,0	11,3	15,1	25	16,4
06.4022.97.GU	KA 3815	150	2175	25	6,6	7,3	9,8	38	10,0	11,1	14,9	45	11,9	13,1	17,6	25	19
06.4023.97.GU	KA 4215	150	2175	28	7,4	8,1	10,9	42	11,1	12,3	16,5	-	-	-	-	25	21
06.4024.97.GU	KA 4815	150	2175	32	8,5	9,3	12,5	48	12,7	14	18,8	-	-	-	-	25	24

GRAFICO PRESTAZIONI PERFORMANCE CHART

