

# CPQ LCK Series

## CPQ 9020 LCK



87 l/m  
23 USGPM



max 200 BAR  
2900 P.S.I.

### APPLICAZIONI - APPLICATIONS



**ANTINCENDIO**  
FIRE PREVENTION



**EDILIZIA**  
CONSTRUCTION



**SPURGO**  
PURGING



**PULIZIA STRADALE**  
STREET CLEANING



**PROCESSI INDUSTRIALI**  
INDUSTRIAL PROCESSES



**INSTALLAZIONI NAVALI**  
NAVAL INSTALLATIONS



**AUTOLAVAGGIO**  
CARWASH



**INSTALLAZIONI AEREOPORTUALI**  
AIRPORT INSTALLATIONS

### TECHNICAL PLUS:



**BIELLE IN BRONZO**  
BRONZE CONRODS



**USCITA ALBERO LATO SX**  
LEFT DRIVE SHAFT



**KIT PIEDINI IN LAMIERA D'ACCIAIO ZINCATI**  
GALVANIZED STEEL MOUNTING RAILS KIT



**GUARNIZIONI TENUTA ACQUA NBR (BUNA)**  
NBR (BUNA) WATER SEALS

### OPTIONAL:



**USCITA ALBERO DX**  
RIGHT DRIVE SHAFT

### SPECIAL TRADEMARK:



**INTELLIseal™**

### GUARNIZIONI - SEALS



**GUARNIZIONI ANTERIORI "Y"**  
**GUARNIZIONI POSTERIORI "Y"**  
"Y" FRONT SEALS - "Y" BACK SEALS

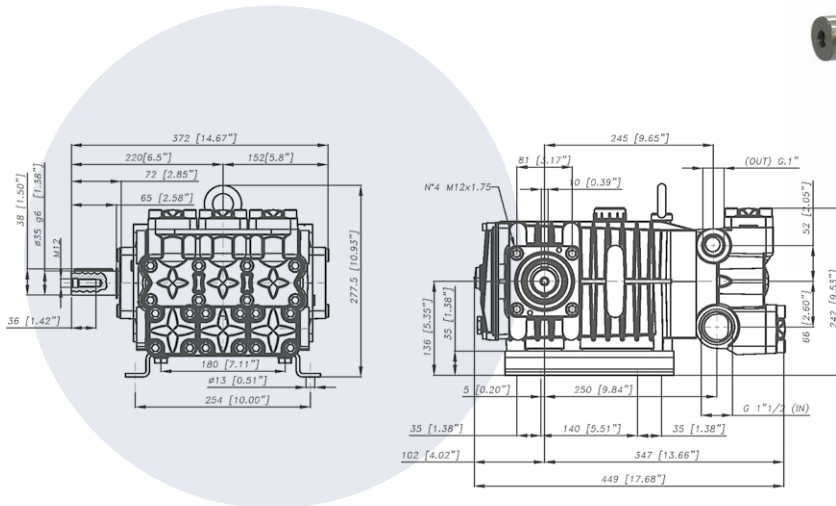

### CARATTERISTICHE TECNICHE SPECIFICATIONS

<b>Peso - Weight</b>	<b>55 Kg</b>	121.3 lb
<b>IN</b>	<b>1"1/2 BSP</b>	
<b>Pressione Min - Min Pressure</b>	<b>-0,2 BAR</b>	-3 P.S.I.
<b>Pressione Max - Max Pressure</b>	<b>6 BAR</b>	87 P.S.I.
<b>OUT</b>	<b>1" BSP</b>	
<b>Albero - Shaft</b>	<b>Ø 35 mm</b>	
<b>Max. Temperatura - Max. Temperature</b>	<b>60 °C</b>	140 °F
<b>Tipo olio - Oil type</b>	<b>SAE 75 - W 90</b>	
<b>Capacità olio - Oil capacity</b>	<b>2,8 lt</b>	0.74 U.S.G.



## TABELLA RENDIMENTI PERFORMANCE CHART

CODICE CODE	MODELLO MODEL	Press Max Max Pres.		RPM 550				RPM 850				RPM 1000				Pist. Plung	Corsa Stroke
		BAR	P.S.I.	L/min	GPM	kW	HP	L/min	GPM	kW	HP	L/min	GPM	kW	HP		
73.8635.97.3	CPQ 9020 LCK	200	2900	62	16,4	24,4	32,7	75	19,8	29,3	39,2	87	23,0	34,1	45,7	30	44
73.8636.97.3	CPQ 1316 LCK	160	2320	89	23,5	28,1	37,6	107	28,3	33,7	45,2	125	33,0	39,2	52,6	36	44
73.8637.97.3	CPQ 1413 LCK	130	1885	100	26,4	25,6	34,3	121	32,0	30,7	41,2	141	37,3	35,8	48,0	40	40
73.8638.97.3	CPQ 1613 LCK	130	1885	110	29,1	28,1	37,7	133	35,1	33,8	45,3	155	41,0	39,4	52,8	40	44

## GRAFICO PRESTAZIONI PERFORMANCE CHART

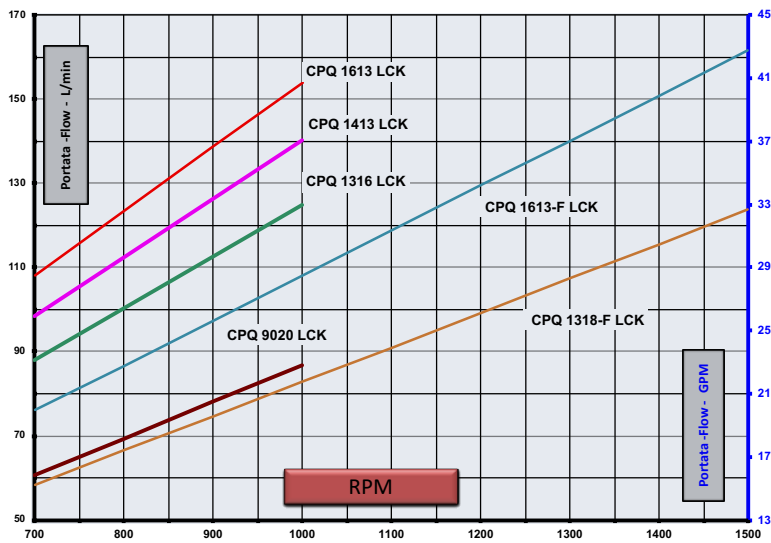



## USCITA POTENZA OUTLET POWER SOURCE

Accoppiamento albero uscita supplementare, per azionamento accessori.  
*Extra shaft coupling to drive accessories.*

