

3"PG-W 1" Series 3PG 4040-W



16.1 l/m
4.2 USGPM



max 280 BAR
4060 P.S.I.

APPLICAZIONI - APPLICATIONS



MANUTENZIONE
MAINTENANCE



PULIZIA SUPERFICI
SURFACE CLEANING



AUTOLAVAGGIO
CARWASH



PULIZIA VASCHE
TANK CLEANING



SANIFICAZIONE
SANITIZATION



EDILIZIA
CONSTRUCTION

TECHNICAL PLUS:



USCITA ALBERO DX
RIGHT DRIVE SHAFT



BIELLE IN BRONZO
BRONZE CONRODS



GUARNIZIONI TENUTA ACQUA NBR (BUNA)
NBR (BUNA) WATER SEALS

OPTIONAL:



USCITA ALBERO LATO SX
LEFT DRIVE SHAFT

GUARNIZIONI - SEALS



GUARNIZIONI ANTERIORI
SUPER "U" - POSTERIORI "U"
SUPER "U" FRONT SEALS "U"
BACK SEALS

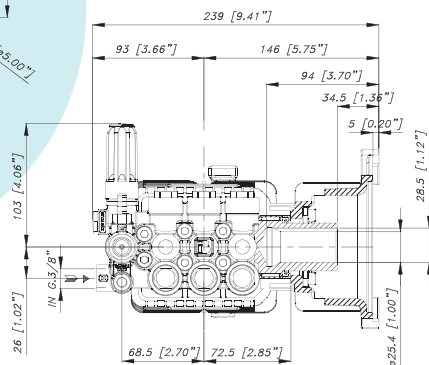
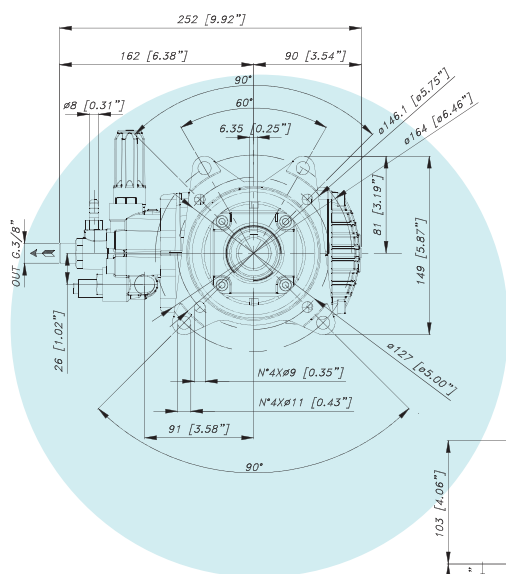

CARATTERISTICHE TECNICHE SPECIFICATIONS

Peso - Weight	6,3 Kg	13 lb
IN	3/8 BSP	
Pressione Min - Min Pressure	1 BAR	15 P.S.I.
Pressione Max - Max Pressure	6 BAR	87 P.S.I.
OUT	3/8 BSP	
Albero - Shaft	HOLLOW 1"	
Max. Temperatura - Max. Temperature	60 °C	140 °F
Tipo olio - Oil type	SAE 75 - W 90	
Capacità olio - Oil capacity	0,5 lt	0.13 U.S.G.
Predisposta per motore - For Motor	SAE J609-1"	

3"PG-W 1" Series

3PG 4040-W



16.1 l/m
4.2 USGPM



max 280 BAR
4060 P.S.I.

CODICE CODE	MODELLO MODEL	Press. Max Max Pres.		RPM 2800				RPM 3000				RPM 3450				Pist. Plung.	Corsa Stroke
				Portata-Flow		Potenza-Power		Portata-Flow		Potenza-Power		Portata-Flow		Potenza-Power			
		BAR	P.S.I.	L/min	GPM	KW	HP	L/min	GPM	KW	HP	L/min	GPM	KW	HP	Dia. mm	mm
02.7050.97.3	3PG 4040-W	280	4060	13,3	3,5	7,3	9,8	14,2	3,8	7,8	10,5	16,1	4,2	8,8	11,8	13	13
02.7051.97.3	3PG 4035-W	280	4060	11,7	3,1	6,4	8,6	12,5	3,3	6,9	9,2	14,1	3,7	7,7	10,4	13	11,4
02.7052.97.3	3PG 4030-W	280	4060	10,0	2,6	5,5	7,4	10,7	2,8	5,9	7,9	12,1	3,2	6,7	8,9	13	9,8
02.7053.97.3	3PG 4025-W	280	4060	8,8	2,3	4,8	6,5	9,4	2,5	5,2	7,0	10,6	2,8	5,8	7,8	13	8,6

Con valvola depressurizzatrice incorporata e eiettore detergente regolabile.
With unloader valve and adjustable injector built-in.